



**WORKLIGHTS**



<b>Contents</b> .....	<b>02</b>
Working light .....	04
Choosing the right product .....	06
The Lighting Lexicon .....	08
<b>Fitting recommendations</b> .....	<b>10</b>
Agricultural and forestry vehicles .....	11
Construction vehicles .....	24
Forklifts .....	28
Vehicles for commercial use .....	30
Municipal vehicles .....	37
Emergency vehicles .....	41
Snow ploughs .....	44
<b>HELLA product range</b> .....	<b>46</b>
LED Worklights .....	48
HALOGEN worklights .....	72
Reversing spotlight .....	84
Headlight .....	88
Beacons .....	90
Accessories .....	92
<b>Something to know</b> .....	<b>96</b>
HELLA AFTERMARKET .....	96
HELLA Innovations .....	98
FAQs .....	100
Protection classes .....	105
HELLA quality .....	106
Online tools and apps .....	110



**A strong argument for better working light**  
 Worklights from HELLA provide you with optimum lighting conditions, even in the dark, allowing you to work faster, with greater precision and improved productivity.

**Pages 04 – 05**

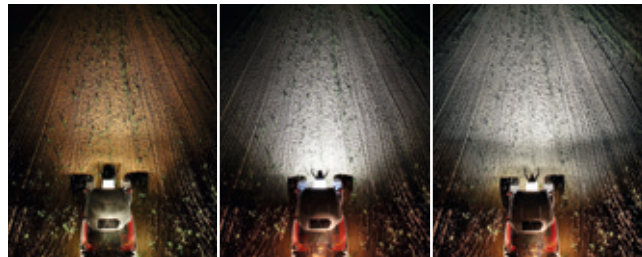

**Lighting technology – what you need to know!**  
 Everything you need to know about the different lighting technologies.

**Page 96**

**Worklights mobile app – see more.**



Turn your smartphone into an info display.



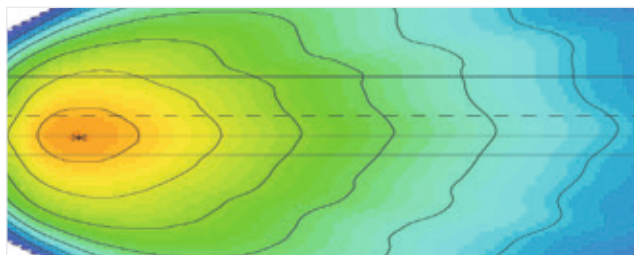

**The technical lighting concept**

What the lumen output says about the brightness and light of a worklight.

Pages 08 – 09



**Easy answers to technical questions**

Questions and answers to technical aspects of worklights.

From page 100



**How it works...**

Use the FREE HELLA Worklights app to access extra content and find out more about our products.

1. Install the FREE HELLA Worklights app on your smartphone or tablet (Apple iOS or Android).

2. Open the app and scan in the pages where you see the smartphone symbol.

Tip: hold your smartphone or tablet at an angle of about 45° to the page when scanning.



**The different usage scenarios – fitting and product recommendations.**

Find out more about the many worklights available for a huge range of requirements.

From page 10



**HELLA quality: a comparison**

Find out in detail why supposedly cheap products from other suppliers can turn out to be very expensive.

From page 106



**Scan symbol:**

Detailed information, 360° views, films, light distributions, specials and much more are indicated by this symbol.

## There's much to be said for better worklights!

Working faster, more productively and with greater precision in twilight and darkness requires daylight-quality lighting. HELLA work lights turn night to day.

### Stronger and better working light helps.

Sleep researchers\* in Basel working together with scientists from the Fraunhofer Institute for Work Management Organisation have discovered that people react strongly to light. For example, the colour temperature of lighting has a considerable influence on responsiveness and performance. Experiments have proven that people get tired quicker if lighting is too weak in colour and temperature, such as dull yellowish. This is because the body perceives such light as twilight and starts to "switch off". Optimum working light as produced by HELLA worklights help you to remain awake and alert for longer in the evenings, boosting concentration, and thereby raising the night worker's productivity.

### Only quality protects against tiredness.

Scientific studies have shown that the human eye has the capacity to always orient itself to the lightest point of a surface. For relaxed vision, however, balanced illumination is necessary. That is why HELLA's lighting technicians make special efforts to generate a homogenous light pattern. The highly concentrated light in the close range is reduced, and the light beams directed further away. This means eyes do not tire as quickly and the driver can concentrate for longer periods.

### Take advantage of OEM quality.

HELLA quality offers the security of a reliable brand product. HELLA is established as a global original equipment manufacturer to all the leading international vehicle and agricultural machinery manufacturers, as we put emphasis on the highest quality in all areas. For example, all our work lights are subjected to extreme stress tests in development and production. More information on our quality tests can be found on page 106 onward.

### Halogen worklights:

#### The established standard.

Well-known but still up-to-date. You can't go wrong with Halogen worklights from HELLA. An affordable solution to improving the light output of a vehicle and thus increase working convenience in the dark.

- H3 bulbs are largely used in HELLA worklights.
- The light colour of H3 bulbs is 2,500 Kelvin.
- In addition, there are Halogen versions with HB3 and H9 bulbs, featuring greater luminous efficiency and higher color temperatures
- IMPORTANT: HB3 and H9 worklights are only available in 12 volt versions.

### Advantages of H9/HB3 compared to H3

- 1.5-times greater light output thanks to increased luminous flux
- Direct access thanks to an externally accessible bulb
- Straightforward bulb replacement
  - without opening the headlight housing
  - bayonet connection
- 3,200° Kelvin light colour

### LED work lights:

#### The next generation.

The latest LED developments in the worklight field are already so advanced that they even outperform xenon light. Additionally, LEDs offer high colour temperatures of around 6,500 Kelvin, thus guaranteeing illumination just like daylight. Working under these kinds of lighting conditions is gentle on your eyes, and it helps you to stay on task for longer.

### Advantages of LED worklights:

- High light output
- Low power consumption
- Maintenance-free
- Extremely long service life
- Multivolt capable
- 100% dust and waterproof
- High vibration resistance
- Low temperature on the lens

All the advantages of modern LED lighting technology are optimally employed in HELLA worklights.

**Have we awakened your interest? The following pages will tell you everything you need to know about work lights.**



\* Source: "Journal of Applied Physiology"



Halogen worklights:  
The established standard.



LED worklights:  
The next generation.

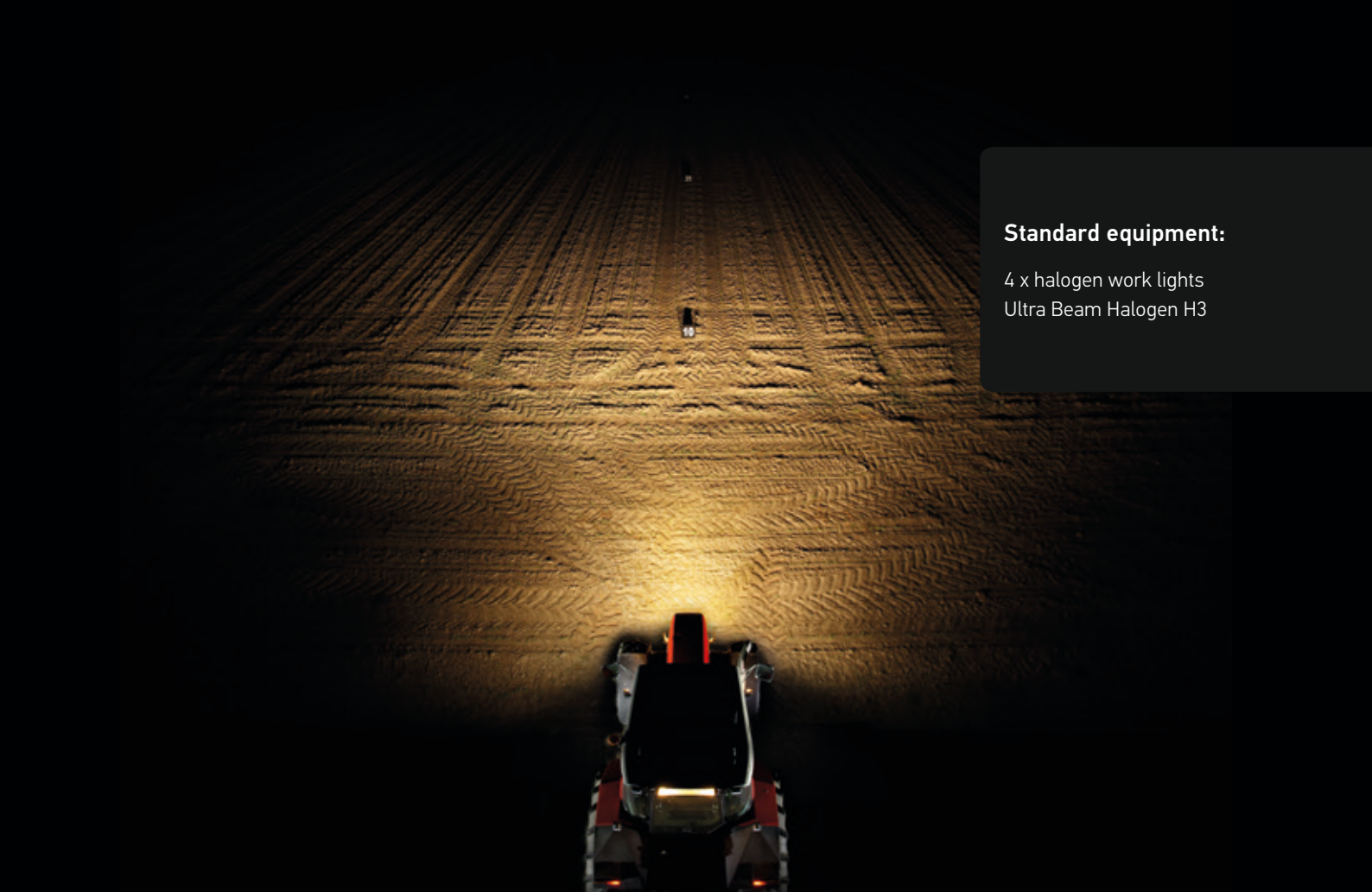

**Standard equipment:**

- 4 x halogen work lights
- Ultra Beam Halogen H3

An improvement in light is an improvement in work quality.

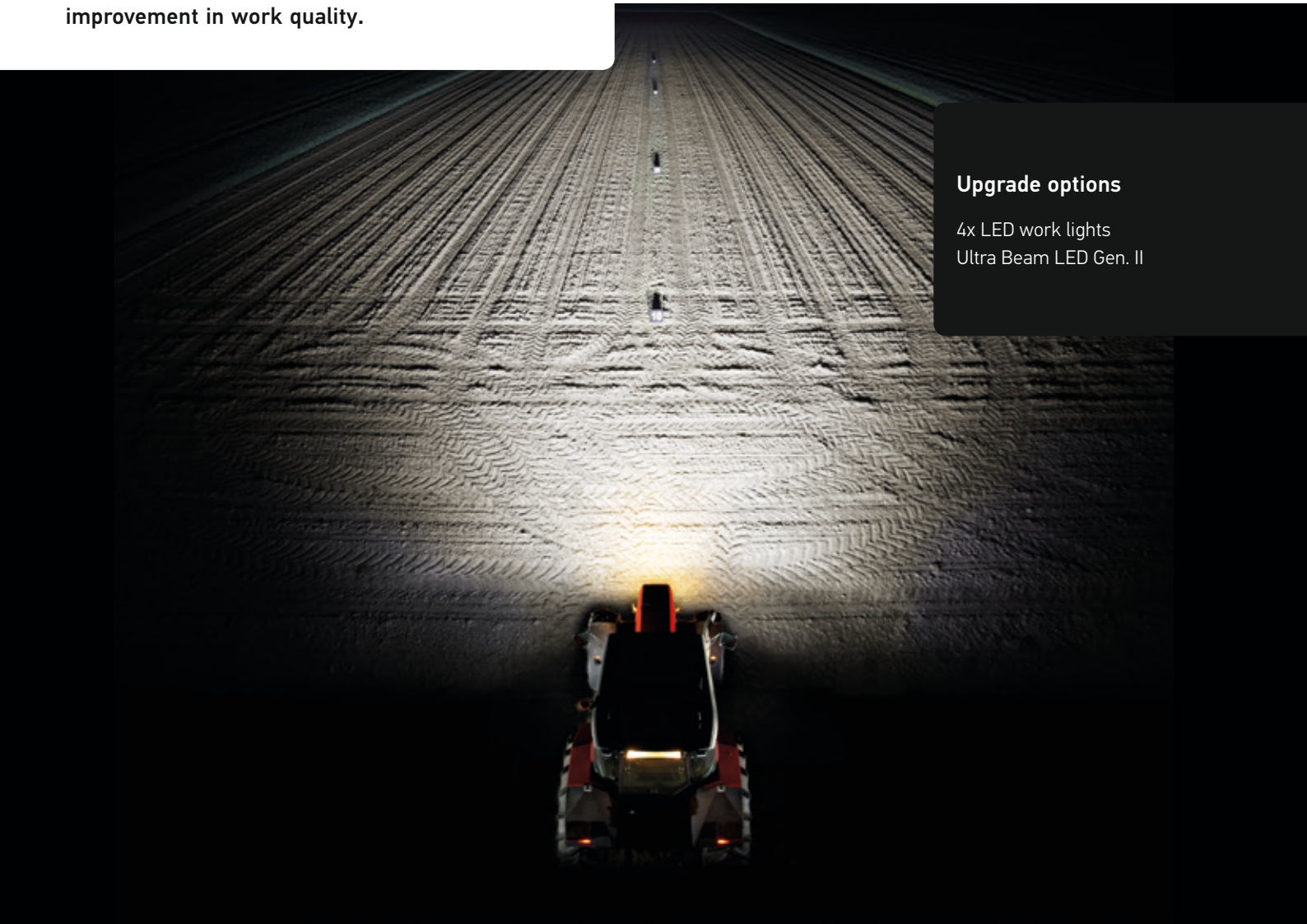

**Upgrade options**

- 4x LED work lights
- Ultra Beam LED Gen. II

## Five questions you should ask yourself before buying new work lights:

### 1. Which lighting technology is already installed?

Analyse what you've already got before choosing a new work light. Only once you know what technology is currently installed can you effectively plan a replacement or lighting upgrade. Is a 1-to-1 replacement of the existing light sufficient, or do you want to increase the light intensity, efficiency and working convenience with more powerful lighting technologies? There are several advantages to switching to powerful LED technology.

### 2. How big is the working area that needs to be illuminated?

This question decides the light intensity you require, because ideal illumination differs for each usage scenario. Do you need long-range, narrow illumination? Or is short-range but intensive close-range illumination sufficient? The greater the range your illumination must ensure, the more light intensity you need.

### 3. Can my existing lights be combined with another lighting technology to improve illumination?

Yes! Additional worklights or partial replacement allow you to improve your illumination gradually, if necessary. There's no need to use the same technology. It is possible to combine existing halogen lighting with new and efficient LED worklights. This keeps the capital outlay low and allows you to benefit from greater luminous efficiency right away. To ensure even illumination, it is important that new lights are always installed in pairs.

### 4. Do I need the worklights to operate in the dark for long periods?

The longer you work in the dark, the more important ideal light conditions are to ensure you stay awake and focused. Halogen light causes fatigue over longer period, while LED light increases concentration and enables more precise and productive work because the human eye perceives it as white daylight. This light is less tiring to the eyes and improves your colour vision.

### 5. How demanding are the outside conditions for the light?

Halogen and Xenon lights are sensitive to vibration. The filaments in the light source may break in the event of strong vibration – with potentially devastating consequences for humans and animals in the work area, or for your own safety. LED worklights, with design lives up to 130 times longer, are recommended because they work without filaments and have the best vibration characteristics.

## Configuration and Effects of Various Types of Illumination



Anyone wishing to work safely and efficiently in the dark fully realizes that high-performance work lights are an absolute must. In addition to a suitable lumen value, it is equally important that the light is evenly distributed throughout the work area. And in order to achieve such a homogenous light distribution, it is advisable to combine work lights that offer different kinds of illuminating features. The HELLA reflector system ensures a smooth distribution of light between the various LED work lights—essential aspects for safe, productive work in the dark.

### 1. Close-Range Illumination

- Usually work lights with a textured cover lens.
- The lens widens the light beams and distributes them homogeneously across the work area.
- This allows you to ensure intensive, large-scale lighting of the entire area around the vehicle.
- And this is just as effective for lighting up equipment in and around the vehicle.
- For situations where the standard close-range illumination is not sufficient, HELLA offers special, extra-wide-beam work lights.

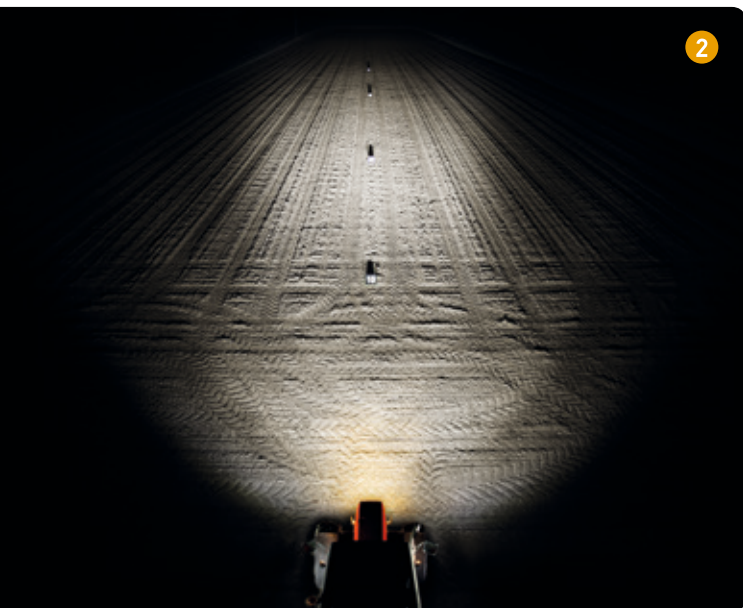

### 2. Long-Range Illumination

- A narrow light pattern where the brightest point shines at the ground at least 30 to 40 m away from the vehicle.
- This is recommended for fast-moving vehicles so you can work safely at night without worrying about an accident.
- This enables good long-range visibility.
- For special applications, extra-wide-beam illumination (spots that reach up to 300 m) is also available.



### 3. Combination

- The ideal illumination conditions for work are provided by a combination of these two lighting options.
- The tilt angle and lateral alignment of the individual devices must be adjusted accordingly.
- The lamps must be aligned in such a way that the long-range and close-range illumination work well together and the transition between them is smooth.
- Dark areas hamper a person's ability to concentrate, and can quickly lead to fatigue. As such, they should be avoided.



## What the lumen output says about the brightness and light of a worklight.

The luminous flux emanating from a light source is measured in the physical unit of lumen (lm).

The lumen output of a light indicates how brightly the light it produces is perceived. This makes lumen output a better reference than the wattage, which only indicates the power consumption of a light rather than how much brightness it actually produces. To aid easy comparison, the following overviews therefore list the lumen outputs of individual products. However, the lumen output is not the only factor that determines how well a light can illuminate a work area.

### Even more important than lumen: the quality of the illumination

Homogeneous distribution of light is more important for optimum working light than the luminous flux from the light measured in lumen. The true quality of a light can be seen in the overall lighting technology concept which, with HELLA worklights, ensures extremely even illumination of the work area without shadows.

### HELLA worklight quality factors.

The interplay and quality of the lighting technology components in a worklight are crucial to achieving ideal light conditions:

#### 1. Quality of the light sources

Stringent tests and selection ensure an extremely long design life, e.g. up to 60,000 hours for LEDs.

#### 2. Quality of the reflector system

For homogenous light distribution, the reflectors are designed to reduce light concentration at close range and ensure a constant increase in illumination as the distance increases.

#### 3. Quality of the lens material

Thanks to the use of premium, impact-resistant and scratch-proof synthetic material, the light emitted remains homogeneous, even after colliding with a branch or anything similar.

#### Note:

HELLA has once more raised the bar in the field of lighting by producing the world's first glare-free work light. The innovative ZEROGLARE technology not only offers excellent close-range lighting – it also represents an immense improvement in safety while performing work tasks. Find out more on page 99.

### The HELLA reflector system:

#### Optimum utilisation of lumen for homogenous illumination of the work area.

The reflector system is at the heart of HELLA's innovative lighting concept. Design is aided by the HELIOS software which tests the light distribution of a new reflector using an average of a million separate, simulated light beams.

This makes it possible for HELLA to ensure that worklights evenly illuminate the work area, prevent the separate lights from causing any interference or shadowing together and produce a harmonious light pattern. This is very important, because the human eye automatically focuses on the brightest point of a surface. That's also why worklights should always be replaced in pairs to prevent uneven illumination of the work area.

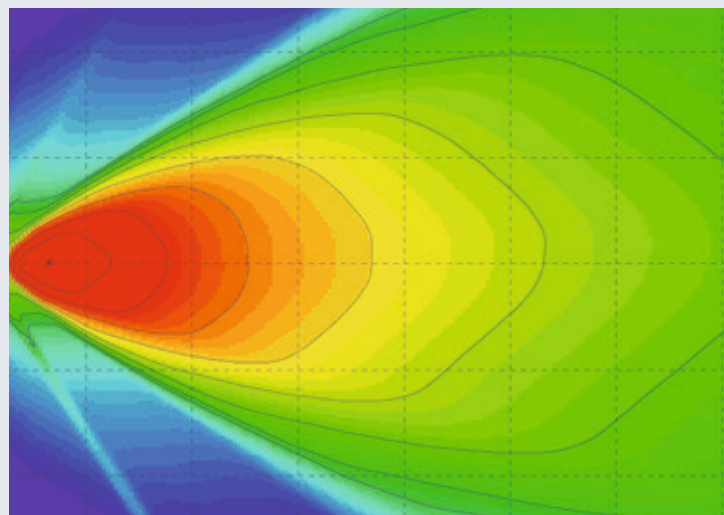

Computer simulation of the superimposed light produced by 2 x Oval 90 LED worklights shows how a harmonious overall pattern is produced.



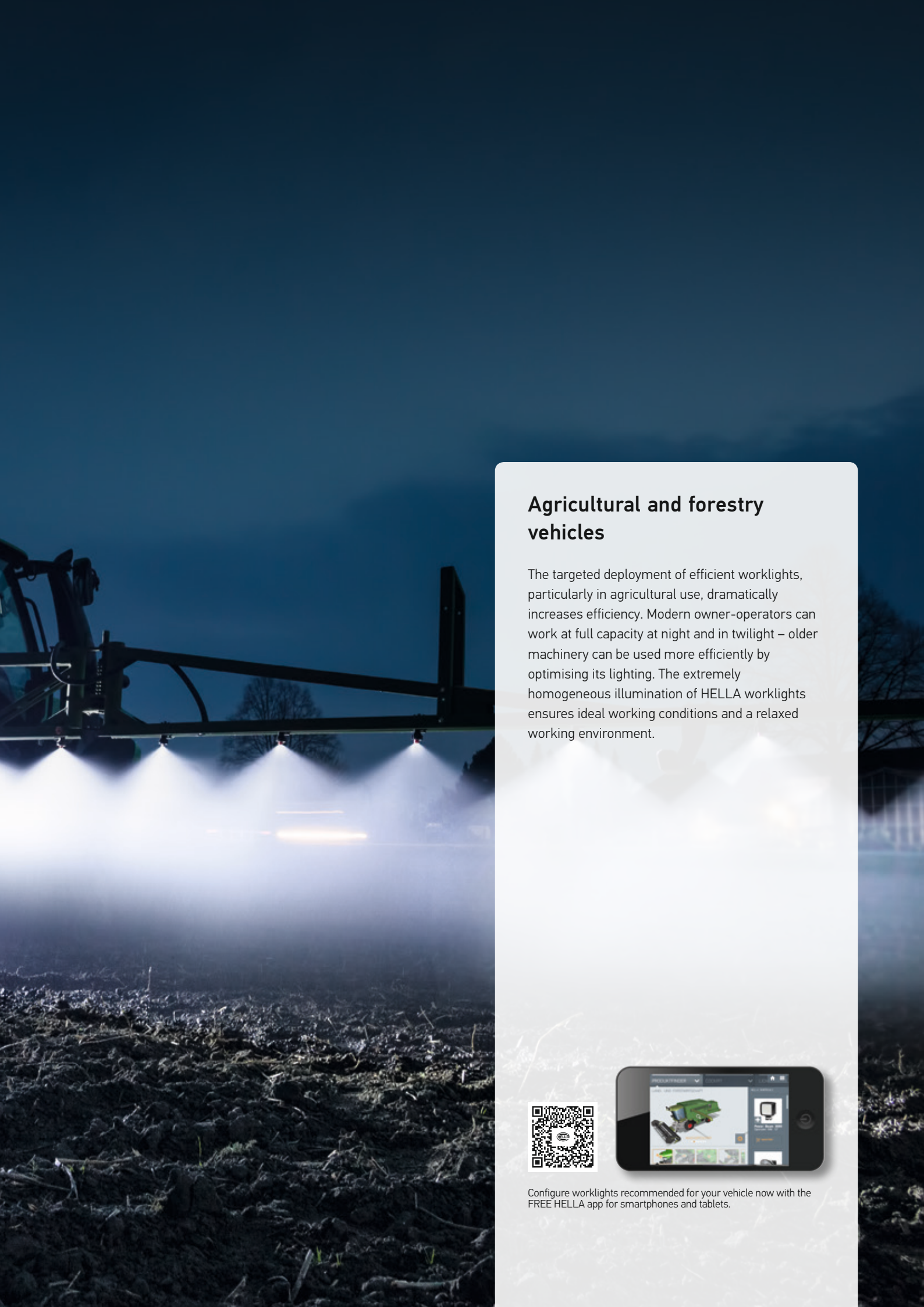

## Agricultural and forestry vehicles

The targeted deployment of efficient worklights, particularly in agricultural use, dramatically increases efficiency. Modern owner-operators can work at full capacity at night and in twilight – older machinery can be used more efficiently by optimising its lighting. The extremely homogeneous illumination of HELLA worklights ensures ideal working conditions and a relaxed working environment.



Configure worklights recommended for your vehicle now with the FREE HELLA app for smartphones and tablets.



HELLA product recommendation

**Tractor:  
Cab roof, front**



**Ultra Beam LED Gen. II**  
1GA 995 606-011

- All-rounder with outstanding luminous efficiency
- Compact design enables installation in many different cabs
- Fast and reliable installation with DT connectors

Close-range illumination  
Page 50



**Oval 90 LED Gen. II**  
1GB 996 486-001

- Extremely wide illumination thanks to the convex cover lens
- Ideal for wide illumination of a work area

Close-range illumination  
Page 60



**Modul 70 LED Gen. IV**  
1G0 996 476-001

- Ideal for mounting positions where space is limited

Close-range illumination  
Page 52



**Tractor:  
Cab roof, rear**



**Ultra Beam LED**  
1GA 995 506-011

- Space-saving positioning on the cab roof thanks to compact design
- Powerful light output

Close-range illumination  
Page 51



**Oval 90 LED**  
1GB 996 386-001

- Extremely wide illumination thanks to the convex cover lens
- Ideal for wide illumination of a work area

Close-range illumination  
Page 61



**Power Beam 1800**  
1GA 996 388-001

- The flat design of the Power Beam 1800 makes it ideal for mounting at the rear of the cab

Close-range illumination  
Page 57





HELLA product recommendation

### Tractor: Rear wing



**Modul 90 LED**  
1G0 996 263-031

- High light output with compact design
- Excellent value for money

Close-range illumination  
Page 59



**Oval 100 LED Gen. II**  
1GA 996 761-001

- Suitable for work with wide equipment
- Special optics scatter light over a very wide range

Close-range illumination  
Page 62



**Ultra Beam LED Gen. II**  
1GA 995 606-001

- With a light output of 4,000 lumen, the Ultra Beam LED offers sufficient rear lighting and enables precise working

Close-range illumination  
Page 50



### Tractor: Step-up lighting



**Q90 compact LED**  
1GA 996 284-002

- For safe access to the vehicle interior
- Compact design ideal for illuminating vehicle door area

Close-range illumination  
Page 65



**Flat Beam 500**  
1GA 995 193-001

- The Flat Beam 500 features an extremely compact design
- The luminous efficiency of 550 lumen is perfectly sufficient for reliable vehicle access lighting

Close-range illumination  
Page 67



**Modul 50 LED**  
1G0 995 050-001

- Where space is tight, the Module 50 LED is ideal for illuminating the vehicle door

Close-range illumination  
Page 68



HELLA product recommendation

### Tractor: Mirror bracket



**Modul 70 LED Gen. IV**  
1G0 996 476-001

- Outstanding light values
- Rapid installation with associated mirror mount (8HG 990 263-111)

Close-range illumination  
Page 52



**Module 70 LED Gen. III**  
1G0 996 276-481

- Where less light is needed
- Low weight and homogenous light distribution in the close range
- Matching mirror mount (8HG 990 263-111)

Close-range illumination  
Page 53



**Q90 compact LED**  
1GA 996 284-002

- Ideal for this attachment position thanks to light synthetic material housing
- Reduced vibration, sufficient luminous efficiency
- A good LED upgrade choice together with the mount (8HG 990 263-131)

Close-range illumination  
Page 65

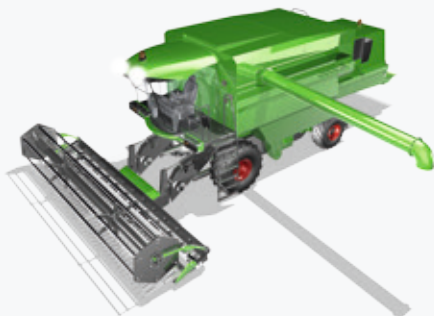

### Combine harvesters: Cab roof, front



**Modul 90 LED**  
1G0 996 263-031

- Outstanding luminous efficiency
- The Modul 90 LED is the ideal solution if there's enough depth at the front of the cab roof

Close-range illumination  
Page 59



**Ultra Beam LED Gen. II**  
1GA 995 606-011

- Space-saving positioning on the cab roof thanks to compact design
- Powerful light output

Close-range illumination  
Page 50



**Oval 90 LED Gen. II**  
1GB 996 486-001

- Extremely wide illumination thanks to the convex cover lens
- Ideal for wide illumination of a work area

Close-range illumination  
Page 60

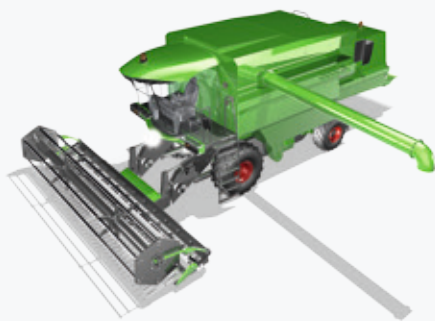

HELLA product recommendation

**Combine harvesters:  
Cab front/bottom**



**Oval 100 LED**  
1GA 996 661-001

- Ideal for wide combine harvesters
- Special optics scatter light over a very wide and homogeneous range

Close-range illumination  
Page 63



**Power Beam 1500**  
1GA 996 288-011

- Wide, homogeneous close-range illumination

Close-range illumination  
Page 58

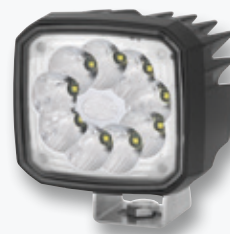

**Ultra Beam LED**  
1GA 995 506-011

- The Ultra Beam LED with 2,200 lumen is recommended if more light is required

Close-range illumination  
Page 51

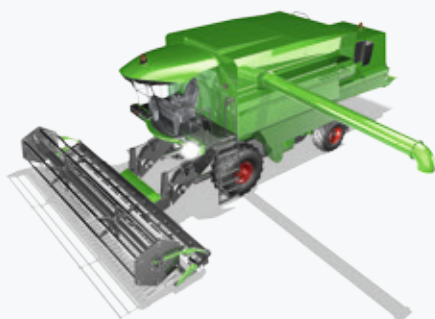

**Combine harvesters:  
Cab bottom/side**



**Power Beam 1500**  
1GA 996 288-011

- Flat design
- Homogeneous close-range illumination

Close-range illumination  
Page 58



**Module 70 LED Gen. III**  
1G0 996 276-481

- Where less light is needed
- Low weight and homogenous light distribution in the close range
- Matching mirror mount (8HG 990 263-111)

Close-range illumination  
Page 53



**Ultra Beam LED**  
1GA 995 506-001

- The Ultra Beam LED with 2,200 lumen is recommended if more light is required

Close-range illumination  
Page 51

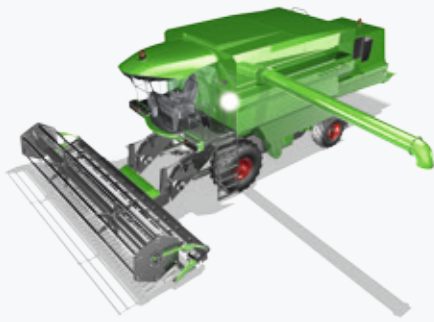

HELLA product recommendation

### Combine harvesters: Mirror bracket



**Modul 70 LED Gen. IV**  
1G0 996 476-001

- Outstanding light values
- Rapid installation with associated mirror mount (8HG 990 263-111)

Close-range illumination  
Page 52



**Oval 100 LED TP**  
1GA 996 661-031

- Ideal for this attachment position thanks to light synthetic material housing
- Reduced vibration, good luminous efficiency
- A good LED upgrade choice together with the mount (8HG 990 263-131)

Close-range illumination  
Page 64



**Q90 compact LED**  
1GA 996 284-002

- Ideal for this attachment position thanks to light synthetic material housing
- Reduced vibration, sufficient luminous efficiency
- A good LED upgrade choice together with the mount (8HG 990 263-131)

Close-range illumination  
Page 65

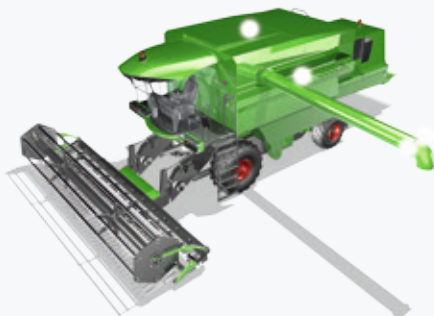

### Combine harvesters: Side wall, top



**Flat Beam 1000**  
1GD 996 193-051

- Thanks to its flat design and 45° downward illumination, it is ideal for mounting on the side of the vehicle. It offers wide-beam, homogenous close-range illumination right by the vehicle.

Close-range illumination  
Page 66



**Power Beam 1500**  
1GA 996 288-011

- Wide, homogeneous close-range illumination makes the Power Beam 1500 the ideal worklight for a range of mounting positions on combine harvesters.

Close-range illumination  
Page 58



**Q90 compact LED**  
1GA 996 284-002

- Flat, space-saving design
- Light synthetic material housing

Close-range illumination  
Page 65





HELLA product recommendation

### Combine harvesters: Tail board



**Oval 100 LED**  
1GA 996 661-001

- Ideal for wide combine harvesters
- Special optics scatter light over a very wide and homogeneous range

Close-range illumination  
Page 63



**Power Beam 1500**  
1GA 996 288-011

- The flat design of the Power Beam 1500 is ideal for installation at the rear of the cab

Close-range illumination  
Page 58



**Ultra Beam LED**  
1GA 995 506-001

- Ideal for maintenance at the rear end of the vehicle
- 2,200 lumen illuminate the whole area behind the vehicle

Close-range illumination  
Page 51

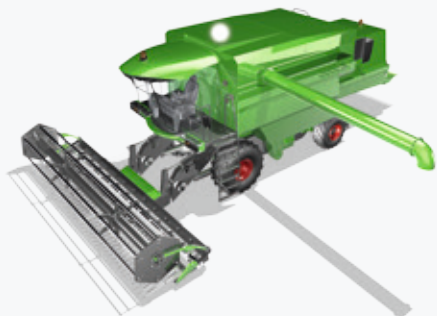

### Combine harvesters: On the grain tank



**Modul 70 LED Gen. IV**  
1G0 996 476-001

- Compact dimensions and excellent light values enable safe and consistent working
- The Modul 70 LED is recommended for good visibility of the combine harvester's discharge opening, even at night

Close-range illumination  
Page 52



**Q90 compact LED**  
1GA 996 284-002

- Wide, homogeneous close-range illumination
- Flat design

Close-range illumination  
Page 65



**Module 70 LED Gen. III**  
1G0 996 276-481

- Where less light is needed
- Low weight and homogenous light distribution in the close range

Close-range illumination  
Page 53



HELLA product recommendation

### Combine harvesters: In the grain tank and service light



**Flat Beam 500**  
1GA 995 193-001

→ The ultra-flat Flat Beam 500 is recommended as a service light in the grain tank



**Q90 compact LED**  
1GA 996 284-002

→ Thanks to its light synthetic material housing and flat design, the Q90 LED is an ideal service light



**Picador H3**  
1GA 998 522-011

→ When less luminous efficiency is sufficient

Close-range illumination  
Page 67

Close-range illumination  
Page 65

Close-range illumination  
Page 73

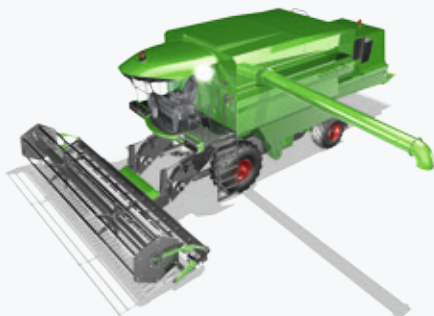

### Combine harvesters: Step-up



**Module 70 LED Gen. III**  
1G0 996 276-481

→ For safe access to the vehicle interior  
→ Compact design ideal for illuminating vehicle door area



**Flat Beam 500**  
1GA 995 193-001

→ The Flat Beam 500 features an extremely compact design  
→ The luminous efficiency of 550 lumen is perfectly sufficient for reliable vehicle access lighting



**Modul 50 LED**  
1G0 995 050-001

→ Where space is tight, the Modul 50 LED is ideal for illuminating the vehicle door

Close-range illumination  
Page 53

Close-range illumination  
Page 67

Close-range illumination  
Page 68





HELLA product recommendation

### Sprayer: Rear wing



**Modul 70 LED blue**  
1G0 996 276-701

- Blue lens for greater efficiency
- Less glare when lighting spray mist, more precise checking of individual nozzle functionality
- 13 watts energy consumption, 800 lm

Close-range illumination  
Page 53



**Modul 70, H9 blue**  
1G0 996 176-671

- Specially developed for sprayer vehicles and snow ploughs
- Less glare when lighting spray mist, allowing more precise checking of individual nozzle functionality

Close-range illumination  
Page 80



**Power Beam 3000**  
1GA 996 192-001

- The Power Beam 3000 with 3,000 lumen is recommended if more light is required

Close-range illumination  
Page 56



### Sprayer: linkage



**Modul 70 LED blue**  
1G0 996 276-701

- When installed on the linkage, the blue Module 70 LED shines straight through the spray mist, making all nozzles visible to the driver without dazzling him

Close-range illumination  
Page 53



**Modul 70, H9 blue**  
1G0 996 176-671

- Less glare when lighting spray mist, allowing more precise checking of individual nozzle functionality

Close-range illumination  
Page 80



**Power Beam 1500**  
1GA 996 288-041

- Narrow, long-range illumination penetrates the spray mist and greatly facilitates work at night

Close-range illumination  
Page 58



HELLA product recommendation

### Harvesters: Cab, front



**RokLUME 380 N**  
1GA 996 197-001

- Brightest illumination up to 100 metres with close-range illumination and up to 300 metres in the long-range version
- Extremely robust and powerful

Close-range illumination  
Page 49



**Ultra Beam LED Gen. II**  
1GA 995 606-011

- Ideal for all-round vehicle lighting

Close-range illumination  
Page 50



**Oval 100 LED Gen. II**  
1GA 996 761-001

- Outstanding light values help the driver to carry out his work precisely and efficiently

Close-range illumination  
Page 62



### Harvesters: Cab, rear/side



**Ultra Beam LED Gen. II**  
1GA 995 606-011

- Compact design enables installation in many different cabs
- Universal all-rounder

Close-range illumination  
Page 50



**Modul 90 LED**  
1G0 996 263-031

- Powerful illumination with compact design
- Excellent value for money

Close-range illumination  
Page 59



**Mega Beam LED Gen. IV**  
1GM 996 136-501

- Sufficient light for the rear view
- Very robust

Close-range illumination  
Page 54





HELLA product recommendation

## Harvesters: Jib



**Ultra Beam LED**  
1GA 995 506-001

- Space-saving thanks to compact design
- Outstanding illumination of the close-range work area

Close-range illumination  
Page 51



**Modul 70 LED Gen. IV**  
1G0 996 476-001

- Compact dimensions and excellent light values enable safe and consistent working

Close-range illumination  
Page 52



**Q90 compact LED**  
1GA 996 284-002

- For situations with heavy vibrations, we recommend the Q 90 compact LED due to its lightweight design

Close-range illumination  
Page 65



## Harvesters: Service light



**Module 70 LED Gen. III**  
1G0 996 276-481

- The compact design of the Module 70 LED offers an excellent solution
- The 800 lumen of the Module 70 LED illuminate the work area all around the vehicle and simplify work at night

Close-range illumination  
Page 53



**Q90 compact LED**  
1GA 996 284-002

- Thanks to its flat design, the Q90 LED is also suitable for this mounting position
- With close-range illumination, the area around the vehicle can be evenly illuminated

Close-range illumination  
Page 65



**Modul 50 LED**  
1G0 995 050-001

- Where space is tight, the Modul 50 LED is an ideal service light

Close-range illumination  
Page 68

HELLA product recommendation

**Forwarder:  
crane**



**Ultra Beam LED Gen. II**  
1GA 995 606-011

→ Even, wide illumination of the entire work area



**Power Beam 3000**  
1GA 996 192-001

→ Suitable where lighting requirements are extremely high



**Power Beam 1500**  
1GA 996 288-011

→ Has long been used in forestry  
→ Outstanding light values help the driver to carry out his work precisely and efficiently

Close-range illumination  
Page 50

Close-range illumination  
Page 56

Close-range illumination  
Page 58

**Forwarder:  
Cab rear panel**



**Power Beam 1500**  
1GA 996 288-011

→ The flat design of the Power Beam 1500 is ideal for installation at the rear of the cab



**Q90 compact LED**  
1GA 996 284-002

→ Flat design  
→ Even, homogenous illumination depending on alignment



**Flat Beam 1000**  
1GD 996 193-001

→ Ideal with its flat design and wide illumination

Close-range illumination  
Page 58

Close-range illumination  
Page 65

Close-range illumination  
Page 66



HELLA product recommendation



**Pick-up:  
Roof, front**



**LED Light Bar 350**  
1GJ 958 040-501

- Flat, low profile
- Wide-beam, homogenous light distribution in front of the vehicle

Close-range illumination  
Page 70



**Ultra Beam LED Gen. II**  
1GA 995 606-011

- With 2,200 lumen, it offers even more light and thus an improvement in work quality

Long-range illumination  
Page 50



**Module 70 LED Gen. III**  
1GA 996 461-311

- 2,800 lumen help the driver to carry out his work precisely and efficiently
- Long-range illumination for good long-distance visibility

Long-range illumination  
Page 53



**Pick-up:  
load area lighting**



**Flat Beam 1000**  
1GD 996 193-051

- Ideal for mounting on the rear panel thanks to its flat design and 45° downward illumination
- The entire bed of the trailer is evenly illuminated, allowing precise and safe work

Close-range illumination  
Page 66



**Q90 compact LED**  
1GA 996 284-002

- Thanks to its compact design, also suitable for this mounting position

Close-range illumination  
Page 65



**Flat Beam 500**  
1GA 995 193-071

- Flat design, excellent value for money

Close-range illumination  
Page 67

## Construction vehicles

Construction sites are a really tough test for any material. Not a problem for HELLA worklights, though, because they have had to undergo tough tests of their own in the testing laboratory and in field trials. This includes a series of tests against water and dust ingress, electromagnetic compatibility tests, thermal tests, endurance tests, electronic tests and vibration tests, of course.



Configure worklights recommended for your vehicle now with the FREE HELLA app for smartphones and tablets.









HELLA product recommendation

### Construction machinery, excavator: Excavator arm, front/rear



**Modul 70 LED Gen. IV**  
1G0 996 476-001

- The excavator arm is somewhere with little space for work lighting
- Compact worklight with excellent light values enables safe and consistent working

Close-range illumination  
Page 52



**Power Beam 1500**  
1GA 996 288-001

- Narrower long-range illumination offers focused illumination of the bucket's work area

Close-range illumination  
Page 58

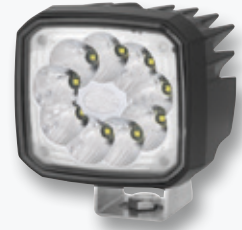

**Ultra Beam LED**  
1GA 995 506-001

- More light is often needed for larger excavators. In such cases, the Ultra Beam LED with 2,200 lumen is recommended.

Close-range illumination  
Page 51



### Construction machinery, excavator: Roof, front/rear



**Modul 90 LED**  
1G0 996 263-031

- Efficient and safe work thanks to 2,700 lumen output

Close-range illumination  
Page 59



**Ultra Beam LED Gen. II**  
1GA 995 606-001

- All-rounder with outstanding luminous efficiency
- Compact design enables installation in many different excavator cabs

Close-range illumination  
Page 50



**LED Light Bar 350**  
1GJ 958 040-501

- Flat, low profile
- Ideal for mounting centrally on the cab roof
- Wide-beam, homogenous light distribution in front of the vehicle

Close-range illumination  
Page 70

HELLA product recommendation



**Asphalt paver:  
Roof, front/rear**



**RokLUME 380 N**  
1GA 996 197-001

- Powerful 7,500 lumen turn night into day to make work easier
- Particularly resistant to vibrations

Close-range illumination  
Page 49



**Ultra Beam LED Gen. II**  
1GA 995 606-001

- Outstanding front light with 4,000 lumen
- Even light distribution helps the driver to carry out his work precisely and efficiently

Close-range illumination  
Page 50



**LED Light Bar 350**  
1GJ 958 040-501

- Space-saving positioning on the cab roof thanks to compact design
- Powerful light output
- Extra-wide-beam illumination

Close-range illumination  
Page 70



**Asphalt paver:  
Wheels, side**



**Q90 compact LED**  
1GA 996 284-002

- Thanks to its flat design, the Q90 LED is suitable for this mounting position
- With close-range illumination, the area around the vehicle can be evenly illuminated

Close-range illumination  
Page 65



**Module 70 LED Gen. III**  
1G0 996 276-481

- Even when mounted low, produces wide illumination of the ground around the vehicle
- 800 lumen with only 13 watts energy consumption

Close-range illumination  
Page 53



**Ultra Beam LED**  
1GA 995 506-001

- The Ultra Beam LED with 2,200 lumen is recommended if more light is required

Close-range illumination  
Page 51

## Forklifts

HELLA worklights are extremely energy efficient. A clear advantage when used on electric forklifts. After all, efficient worklights mean less charging and minimised downtime for the vehicle.



Configure worklights recommended for your vehicle now with the FREE HELLA app for smartphones and tablets.



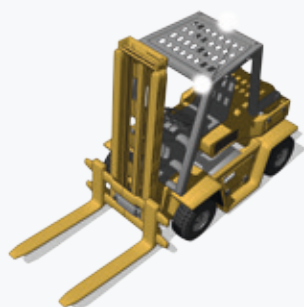

HELLA product recommendation

### Forklift: Roof, front/rear



**Q90 compact LED**  
1GA 996 284-002

- Depending on alignment, either the forklift arm or the rack can be illuminated
- A combination of two worklights is recommended

Close-range illumination  
Page 65



**Module 70 LED Gen. III**  
1G0 996 276-481

- Compact dimensions, low weight and homogenous light distribution
- Low energy consumption (13 W)

Close-range illumination  
Page 53



**Modul 50 LED – Color Spot**  
1G0 996 050-061

- Blue warning sign in front of vehicle for greater safety

Close-range illumination  
Page 69

I108

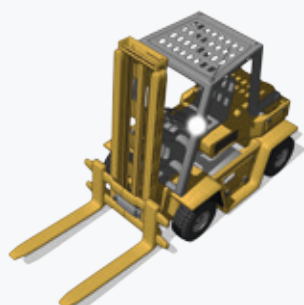

### Forklift: Forklift cab, front



**Mega Beam LED Gen. III**  
1GM 996 136-311

- Excellent light distribution in the close range
- Attractive design

Close-range illumination  
Page 55



**Q90 compact LED**  
1GA 996 284-002

- Depending on alignment, either the forklift arm or the rack can be illuminated
- A combination of two worklights is recommended

Close-range illumination  
Page 65



**Ultra Beam LED**  
1GA 995 506-001

- With 2,200 lumen output, the Ultra Beam LED offers sufficient rear light and enables precise working

Close-range illumination  
Page 51

## Vehicles for commercial use

Wider than others, longer, taller, heavier and more powerful. Heavy and wide loads present drivers with a special challenge – and are often underestimated by other road users. For this reason, the same rule applies to those responsible for fitting out the vehicles with warning systems and worklights as to those responsible for the vehicle condition and load securing actions: only perfect will do! HELLA is delighted with this – after all, we work according to the very same rule.



Configure worklights recommended for your vehicle now with the FREE HELLA app for smartphones and tablets.







HELLA product recommendation

### Commercial vehicles: Cab rear panel, top



**Flat Beam 1000**  
1GD 996 193-051

- Thanks to its flat design and 45° downward illumination, it is ideal for mounting on the rear panel. The entire coupling area of the trailer is evenly illuminated, allowing precise and safe work.

Close-range illumination  
Page 66



**LED Light Bar 350**  
1GJ 958 040-501

- Design allows for ideal installation on the cab rear panel
- The Thermo Pro housing is especially light and vibration-resistant

Close-range illumination  
Page 70



**Power Beam 1800**  
1GA 996 388-041

- The entire coupling area is illuminated, hugely facilitating work in the dark
- Wide, homogenous illumination
- CoroSafe coating for optimum corrosion protection

Close-range illumination  
Page 57



### Commercial vehicles: Cab rear panel, bottom



**Q90 compact LED**  
1GA 996 284-002

- Design allows for ideal installation on the cab rear panel
- Excellent value for money

Close-range illumination  
Page 65



**Power Beam 1800**  
1GA 996 388-041

- The entire coupling area is illuminated, hugely facilitating work in the dark
- Wide, homogenous illumination
- CoroSafe coating for optimum corrosion protection

Close-range illumination  
Page 57



**Flat Beam 500**  
1GA 995 193-021

- The luminous efficiency of 550 lumen is sufficient for even coupling illumination
- Extremely flat mounting depth

Close-range illumination  
Page 67







HELLA product recommendation

### Commercial vehicles: Vehicle rear/side



**Module 70 LED reversing spotlight**  
2ZR 996 376-091

- Approved as a reversing spotlight
- Compact dimensions and special corrosion resistant coating

Close-range illumination  
Page 85



**Q90 Compact LED Reversing Light**  
2ZR 996 284-501

- Approved as a reversing spotlight
- The Thermo Pro housing protects the work light from water ingress and corrosion

Close-range illumination  
Page 65



**Repulse Pro**  
2ZR 012 456-221

- Approved as a reversing spotlight
- Shallow mounting depth (48 mm)
- The energy-saving LED technology (just 11 W) helps to save power and therefore reduces the strain on the alternator

Close-range illumination  
Page 86



### Commercial vehicles: Cab, front



**Modul 70 LED Gen. IV**  
1G0 996 476-001

- Outstanding light values
- Rapid installation with associated mirror mount (8HG 990 263-111)

Close-range illumination  
Page 52



**Module 70 LED Gen. III**  
1G0 996 376-001

- Where less light is needed
- Light weight and good long-range light distribution
- Matching mirror mount (8HG 990 263-111)

Long-range illumination  
Page 53



**Q90 compact LED**  
1GA 996 284-002

- Ideal for this attachment position thanks to light synthetic material housing
- Reduced vibration, sufficient luminous efficiency
- A good LED upgrade choice together with the mount (8HG 990 263-131)

Close-range illumination  
Page 65



HELLA product recommendation

**Tow truck:  
Cab, top**



**Flat Beam 1000**  
1GD 996 193-051

→ Thanks to its flat design and 45° downward illumination, it is ideal for mounting on the rear panel. The entire coupling area of the trailer is evenly illuminated, allowing precise and safe work.

Close-range illumination  
Page 66



**Q90 compact LED**  
1GA 996 284-002

→ Thanks to its flat design, also suitable for this mounting position

Close-range illumination  
Page 65



**LED Light Bar 350**  
1GJ 958 040-501

→ The entire bed is illuminated, hugely facilitating work in the dark  
→ Wide, homogenous illumination

Close-range illumination  
Page 70



**Tow truck:  
Cab, centre**



**Power Beam 1500**  
1GA 996 288-011

→ Wide, homogenous illumination  
→ The entire area around the vehicle is evenly illuminated

Close-range illumination  
Page 58



**Ultra Beam LED**  
1GA 995 506-001

→ The Ultra Beam LED with 2,200 lumen is recommended if more light is required

Close-range illumination  
Page 51



**Flat Beam 1000**  
1GD 996 193-051

→ Flat design and 45° downward illumination make it ideal for mounting on the rear panel  
→ The entire bed of the trailer is evenly illuminated, allowing precise and safe work

Close-range illumination  
Page 66





HELLA product recommendation

### Tow truck: Vehicle rear/side



**Module 70 LED reversing spotlight**  
2ZR 996 376-091

- Approved as a reversing spotlight
- Compact dimensions and special corrosion resistant coating

Close-range illumination  
Page 85



**Q90 Compact LED Reversing Light**  
2ZR 996 284-501

- Approved as a reversing spotlight
- The Thermo Pro housing protects the work light from water ingress and corrosion

Close-range illumination  
Page 86



**Repulse Pro**  
2ZR 012 456-221

- Approved as a reversing spotlight
- Shallow mounting depth (48 mm)
- The energy-saving LED technology (just 11 W) helps to save power and therefore reduces the strain on the alternator

Close-range illumination  
Page 86



### Tow truck: loading platform, bottom



**Flat Beam 500**  
1GA 995 193-021

- Extremely flat design enables installation on any vehicle rear panel
- The luminous efficiency of 550 lumen is sufficient for even bed illumination

Close-range illumination  
Page 67



**Q90 compact LED**  
1GA 996 284-002

- 1,200 lumen of power with a flat design

Close-range illumination  
Page 65



**Power Beam 1500**  
1GA 996 288-011

- Wide, homogenous illumination of the entire bed
- With 1,300 lumen, particularly powerful for this mounting position

Close-range illumination  
Page 58



SO LP 5550



## Municipal vehicles

Their range of applications is versatile. They are used for cleaning pavements, pedestrian zones, roads, runways or even industrial halls. They ensure inner cities are kept clean and sweep all sorts of road surfaces from narrow little alleyways to large public spaces or airports. HELLA worklights help to ensure that no piece of waste is missed and the drivers always have optimum visibility, regardless of where they are sweeping. Resistant to corrosion and reliable, HELLA worklights provide genuine support at work.



Configure worklights recommended for your vehicle now with the FREE HELLA app for smartphones and tablets.



HELLA product recommendation

**Cleaning vehicle, 24 V:  
Mounting back/front**



**Oval 100 LED**  
1GA 996 661-001

→ Special optics particularly scatter light to the sides. This makes it possible to illuminate the entire close range (up to 40 m) around the vehicle.

Close-range illumination  
Page 63



**Ultra Beam LED**  
1GA 995 506-001

→ The Ultra Beam LED with 2,200 lumen is recommended if more light is required

Close-range illumination  
Page 51



**Modul 70 LED Gen. IV**  
1G0 996 476-001

→ Particularly powerful with 2,500 lumen

Close-range illumination  
Page 52



**Cleaning vehicle, 24 V:  
Side of the vehicle, bottom**



**Module 70 LED reversing spotlight**  
2ZR 996 376-091

→ Ideal for illuminating objects such as curb cleaning brushes  
→ The even light distribution hugely facilitates work and ensures excellent driver visibility

Close-range illumination  
Page 85



**Q90 compact LED**  
1GA 996 284-002

→ With 1,000 lumen and a flat design  
→ Particularly suitable for this mounting position

Close-range illumination  
Page 65



**Flat Beam 500**  
1GA 995 193-001

→ The luminous efficiency of 550 lumen is sufficient for even ground illumination in the close range around the vehicle  
→ Space-saving thanks to extremely flat design

Close-range illumination  
Page 67





HELLA product recommendation

### Cleaning vehicle, 24 V: Side of vehicle back/side



**Module 70 LED reversing spotlight**  
2ZR 996 376-091

- Approved as a reversing spotlight
- Compact dimensions and special corrosion resistant coating

Close-range illumination  
Page 85



**Q90 Compact LED Reversing Light**  
2ZR 996 284-501

- Approved as a reversing spotlight
- The Thermo Pro housing protects the work light from water ingress and corrosion

Close-range illumination  
Page 86



**Repulse Pro**  
2ZR 012 456-221

- Approved as a reversing spotlight
- Shallow mounting depth (48 mm)
- The energy-saving LED technology (just 11 W) helps to save power and therefore reduces the strain on the alternator

Close-range illumination  
Page 86



### Cleaning vehicle, 12 V: Roof, top



**Flat Beam 1000**  
1GD 996 193-051

- Thanks to its flat design and 45° downward illumination, it is ideal for mounting on the rear panel. The vehicle's loading area is evenly illuminated, allowing precise and safe work.

Close-range illumination  
Page 66



**Q90 compact LED**  
1GA 996 284-002

- Thanks to its flat design, also suitable for this mounting position

Close-range illumination  
Page 65



**LED Light Bar 350**  
1GJ 958 040-501

- The entire bed is illuminated, hugely facilitating work in the dark
- Wide, homogenous illumination

Close-range illumination  
Page 70



FEUERWEHR

4620

RENNER





## Emergency vehicles

When the fire service is called, it's often a question of life and death. The reliability of the material plays a vital part.

HELLA worklights are subjected to extreme quality tests to ensure they always reliably deliver top performance.



Configure worklights recommended for your vehicle now with the FREE HELLA app for smartphones and tablets.



HELLA product recommendation

### Emergency vehicle: Cab, front



**Power Beam 3000**  
1GA 996 192-011

→ The long-range illumination of the Power Beam 3000 makes it an ideal searchlight for distances of up to 200 metres

Close-range illumination  
Page 56



**Ultra Beam LED Gen. II**  
1GA 995 606-011

→ The Ultra Beam LED, too, is perfect for long-range illumination when installed on the cab of an emergency vehicle  
→ Illumination of up to 150 metres in front of the vehicle is possible

Long-range illumination  
Page 50



**Modul 90 LED**  
1G0 996 263-051

→ The long-range variant of the Module 90 LED is ideal for intensive illumination up to 100 metres  
→ The light is extremely focused and offers outstanding illumination in the work area

Long-range illumination  
Page 59



### Emergency vehicle: Vehicle roof or mast



**Ultra Beam LED Gen. II**  
1GA 995 606-001

→ Vehicle mast illumination has one aim: to provide as much light as possible around the entire vehicle. The Ultra Beam more than meets this requirement, making it ideal for this application

Close-range illumination  
Page 50



**RokLUME 380 N**  
1GA 996 197-001

→ Brightest illumination up to 100 m with close-range illumination and up to 300 m in the long-range version can be achieved with the 7,500 lumen

Close-range illumination  
Page 49



**Modul 90 LED**  
1G0 996 263-031

→ The illumination is also ideal for vehicle masts  
→ The Module 90 LED offers a more affordable alternative while still featuring excellent light values

Close-range illumination  
Page 59



HELLA product recommendation

### Emergency vehicle: Mounting on side top/vehicle rear



**Flat Beam 1000**  
1GD 996 193-051

- The specially developed 45° lens focuses the light directly on the ground, so that, even with flat surface mounting of the light, the beams fall right around the vehicle
- Flat design
- 1,100 lumen output

Close-range illumination  
Page 66



**Flat Beam 500**  
1GA 995 193-021

- Also features the specially developed 45° lens, allowing precise and safe work directly at the vehicle
- 550 lumen output with 7 watts energy consumption

Close-range illumination  
Page 67



**Q90 compact LED**  
1GA 996 284-002

- Space-saving thanks to flat design
- Powerful 1,200 lumen ensure even illumination

Close-range illumination  
Page 65



### Emergency vehicle: Vehicle rear/side



**Module 70 LED reversing spotlight**  
2ZR 996 376-091

- Approved as a reversing spotlight
- Compact dimensions and special corrosion resistant coating

Close-range illumination  
Page 85



**Q90 Compact LED Reversing Light**  
2ZR 996 284-501

- Approved as a reversing spotlight
- The Thermo Pro housing protects the work light from water ingress and corrosion

Close-range illumination  
Page 86



**Repulse Pro**  
2ZR 012 456-221

- Approved as a reversing spotlight
- Shallow mounting depth (48 mm)
- The energy-saving LED technology (just 11 W) helps to save power and therefore reduces the strain on the alternator

Close-range illumination  
Page 86

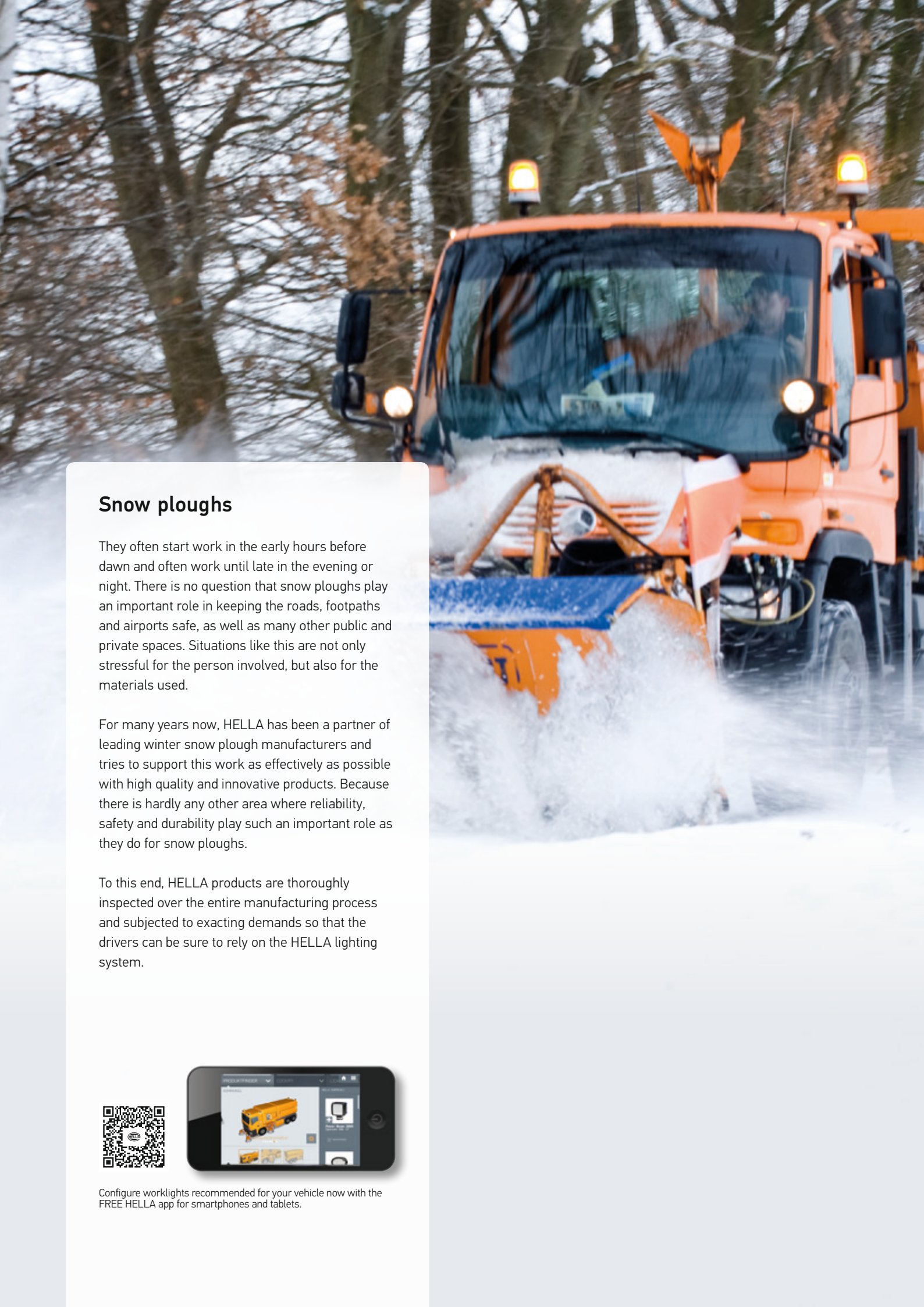

## Snow ploughs

They often start work in the early hours before dawn and often work until late in the evening or night. There is no question that snow ploughs play an important role in keeping the roads, footpaths and airports safe, as well as many other public and private spaces. Situations like this are not only stressful for the person involved, but also for the materials used.

For many years now, HELLA has been a partner of leading winter snow plough manufacturers and tries to support this work as effectively as possible with high quality and innovative products. Because there is hardly any other area where reliability, safety and durability play such an important role as they do for snow ploughs.

To this end, HELLA products are thoroughly inspected over the entire manufacturing process and subjected to exacting demands so that the drivers can be sure to rely on the HELLA lighting system.



Configure worklights recommended for your vehicle now with the FREE HELLA app for smartphones and tablets.



HELLA product recommendation

### Snow ploughs: Roof, front



**Power Beam 1800**  
1GA 996 388-041

- Special optics scatter light homogeneously in front of the vehicle
- 1,850 lumen light output
- CoroSafe coating for optimum corrosion protection

Close-range illumination  
Page 57



**Power Beam 1500**  
1GA 996 288-041

- The orange lens helps to improve work quality

Close-range illumination  
Page 58



**Modul 70 LED blue**  
1G0 996 276-701

- The Module 70 LED blue was specially developed for snow ploughs
- Less dazzle when illuminating spray mist, road salt or snow

Close-range illumination  
Page 53



### Snow ploughs: Cab, side



**Modul 70 LED blue**  
1G0 996 276-701

- The Module 70 LED blue was specially developed for sprayers and snow ploughs. Less dazzle when illuminating spray mist, road salt or snow. In addition, the blue lens improves the nighttime perception of contrast.

Close-range illumination  
Page 53



**Modul 70, H9 blue**  
1G0 996 176-671

- Less glare when lighting spray mist, allowing more precise checking of individual nozzle functionality

Close-range illumination  
Page 80



**Power Beam 1500**  
1GA 996 288-041

- Narrow, long-range illumination penetrates the spray mist and greatly facilitates work at night

Close-range illumination  
Page 58





## Worklights “quick finder”

<b>LED product range</b> .....	<b>48</b>
RokLUME 380 N .....	49
Ultra Beam LED Gen. II .....	50
Ultra Beam LED .....	51
Module 70 LED Gen. IV .....	52
Module 70 LED Gen. III .....	53
Mega Beam LED Gen. IV .....	54
Mega Beam LED Gen. III .....	55
Power Beam 3000 .....	56
Power Beam 1800 .....	57
Power Beam 1500 .....	58
Modul 90 LED .....	59
Oval 90 LED Gen. II .....	60
Oval 90 LED .....	61
Oval 100 LED Gen. II .....	62
Oval 100 LED .....	63
Oval 100 LED TP .....	64
Q90 compact LED .....	65
Flat Beam 1000 .....	66
Flat Beam 500 .....	67
Modul 50 LED .....	68
Modul 50 LED – Color spot .....	69
LED Light Bar 350 .....	70
LED Light Bar 350 accessories .....	71
<b>HALOGEN product range</b> .....	<b>72</b>
Picador .....	73
Ultra Beam .....	74
Ultra Beam with handle .....	75
Oval 100 Double Beam .....	76
Oval 100 .....	77
Master .....	78
Double Beam .....	79
Modul 70, H9 .....	80
Modul 70, H3 .....	81
Mega Beam .....	82
Matador .....	83
<b>Reversing spotlight</b> .....	<b>84</b>

## LED Worklights





## RokLUME 380 N

### Product features

- Breathtaking light output
- Developed for the toughest conditions
- Heavy Duty bracket for particularly high vibration resistance

### Technical details

Light output (measured): up to 7,500 lumen, power requirement: max. 84 watts, colour temperature: 5,000°Kelvin, 24 volts, polarity reversal protection, overvoltage protection, thermal management, IP 6K9K / IP 6K8 (pressure cleaner-proof / submersible), high-quality aluminum housing, NanoSafe coating, ECE-R10, RCM-approved

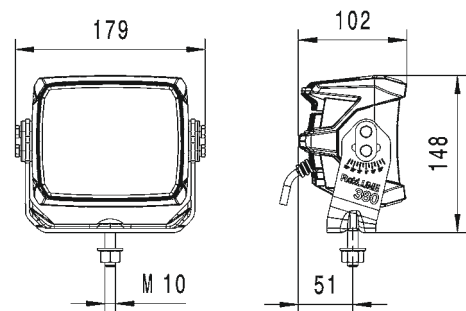

### Illumination

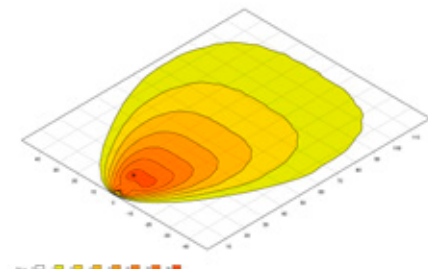

Close-range illumination

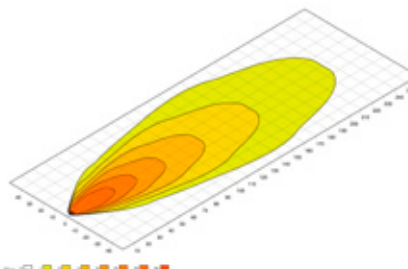

Long-range illumination

Recommended tilt angle | Close-range: 12°, long-range: 5°

1GA 996 197-...	-001	-031	-021
Voltage	22 – 32 V	22 – 32 V	22 – 32 V
Close-range illumination	X	X	-
Long-range illumination	-	-	X
Spot illumination	-	-	-
Energy consumption	max. 84 W	max. 84 W	max. 84 W
Lumen (hot)	-	7,500 lm	7,500 lm
Electrical connection	150 mm cable and DT connector	150 mm cable and DT connector	150 mm cable and DT connector
Upright mounting	X	X	X
Suspended mounting	X	X	X
Mounting, lateral	-	-	-
Bracket width	152 mm	152 mm	152 mm
Other features	ZEROGLARE optics	-	-

## Ultra Beam LED Gen. II

### Product features

- The most powerful Ultra Beam ever
- Light output surpasses xenon performance
- Twice as much light as Generation 1



### Technical details

Light output (measured): 4,000 lumen, power requirement: 56 watts, colour temperature: 6,500°Kelvin, multivolt, polarity reversal protection, overvoltage protection, thermal management, IP 6K9K / IP 6K8 (pressure cleaner-proof / submersible), ECE-R10-approved, high-quality aluminium housing, ADR/GGVSEB-tested

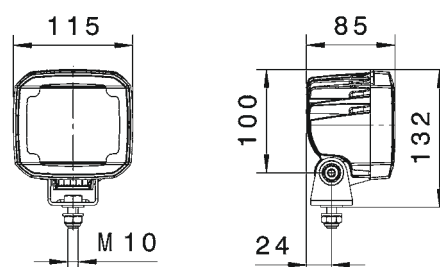

### Illumination

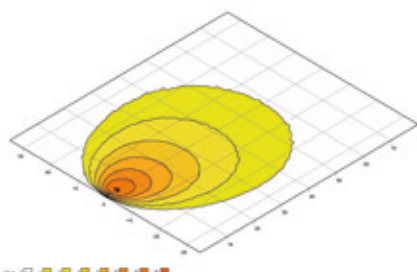

Close-range illumination

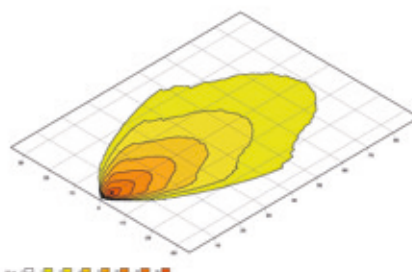

Long-range illumination

Recommended tilt angle | Close-range: 12°, long-range: 5°

1GA 995 606-...	-001	-011	-081	-091
Voltage	9 – 33 V	9 – 33 V	9 – 33 V	9 – 33 V
Close-range illumination	X	-	X	-
Long-range illumination	-	X	-	X
Spot illumination	-	-	-	-
Energy consumption	56 W	56 W	56 W	56 W
Lumen (hot)	4,000 lm	4,000 lm	4,000 lm	4,000 lm
Electrical connection	DT connector	DT connector	DT connector	DT connector
Upright mounting	X	X	X	X
Suspended mounting	X	X	X	X
Mounting, lateral	-	-	-	-
Bracket width	42 mm	42 mm	116 mm	116 mm
Other features	-	-	Heavy Duty surrounding bracket	Heavy Duty surrounding bracket

## Ultra Beam LED

### Product features

- Xenon-quality light output
- Simple retrofit for universal use
- Particularly homogeneous illumination of the work area



### Technical details

Light output (measured): 2,200 lumen, power requirement: 30 watts, colour temperature: 6,500°Kelvin, multivolt, polarity reversal protection, overvoltage protection, thermal management, IP 6K9K / IP 6K8 (pressure cleaner-proof / submersible), ECE-R10-approved, high-quality aluminium housing, ADR/GGVSEB-tested

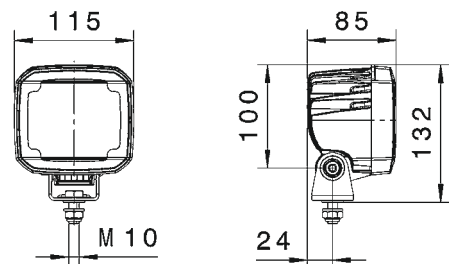

### Illumination

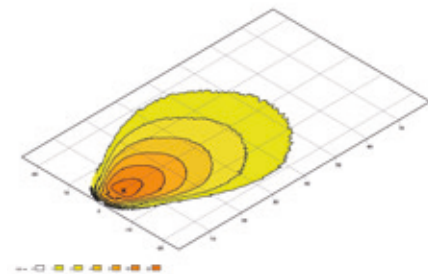

Close-range illumination

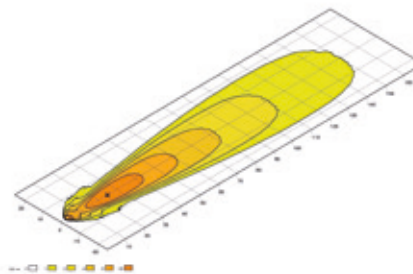

Long-range illumination

Recommended tilt angle: 12°, far: 5°

1GA 995 506-...	-001	-011	-031
Voltage	9 – 33 V	9 – 33 V	9 – 33 V
Close-range illumination	X	X	-
Long-range illumination	-	-	X
Spot illumination	-	-	-
Energy consumption	30 W	30 W	30 W
Lumen (hot)	2,200 lm	2,200 lm	2,200 lm
Electrical connection	DT connector	DT connector	DT connector
Upright mounting	X	-	X
Suspended mounting	-	X	X
Mounting, lateral	-	-	-
Bracket width	42 mm	42 mm	42 mm
Other features	-	-	-

## Module 70 LED Gen. IV

### Product features

- The most powerful of its size on the market
- For anyone who needs a lot of light in a little space



### Technical details

Light output (measured): 2,500 lumen, power requirement: 30 watts, colour temperature: 6,500°Kelvin, multivolt, polarity reversal protection, overvoltage protection, thermal management, IP 6K9K / IP 6K8 (pressure cleaner-proof / submersible), ECE-R10 approved, high-quality aluminium housing

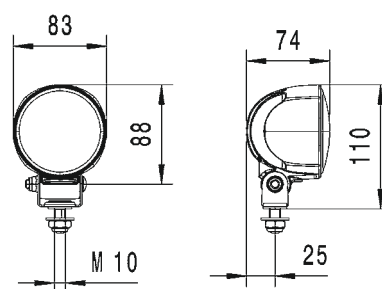

### Illumination

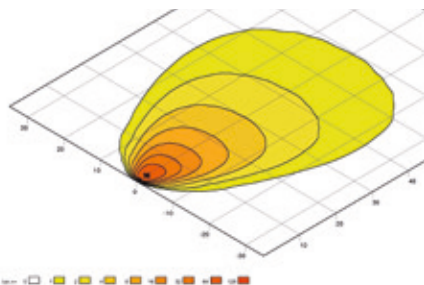

Close-range illumination

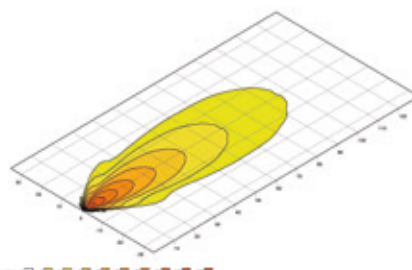

Long-range illumination

Recommended tilt angle: 12°, far: 5°

1G0 996 476-...	-001	-011	-031
Voltage	9 – 33 V	9 – 33 V	9 – 33 V
Close-range illumination	X	-	X
Long-range illumination	-	X	-
Spot illumination	-	-	-
Energy consumption	30 W	30 W	30 W
Lumen (hot)	2,500 lm	2,500 lm	2,500 lm
Electrical connection	2,000 mm cable	2,000 mm cable	2,000 mm cable
Upright mounting	X	X	X
Suspended mounting	X	X	X
Mounting, lateral	-	-	-
Bracket width	36 mm	36 mm	36 mm
Other features	-	-	Extra-wide illumination

## Module 70 LED Gen. III

### Product features

- Compact design enables a variety of different mounting positions
- Ideal for battery-powered vehicles or an alternator that is already heavily stressed



### Technical details

Light output (measured): 800 lumen, power requirement: 13 watts, colour temperature: 6,500°Kelvin, multivolt, polarity reversal protection, overvoltage protection, thermal management, IP 6K9K / IP 6K8 (pressure cleaner-proof / submersible), ECE-R10-approved, high-quality aluminium housing

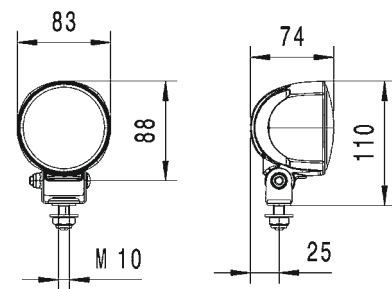

### Illumination

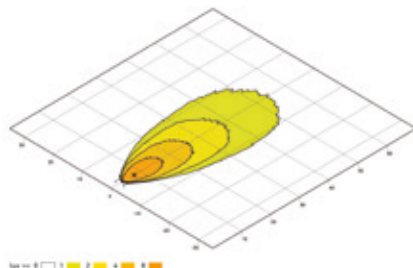

Close-range illumination

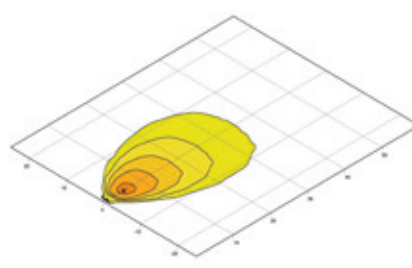

Extra-wide illumination

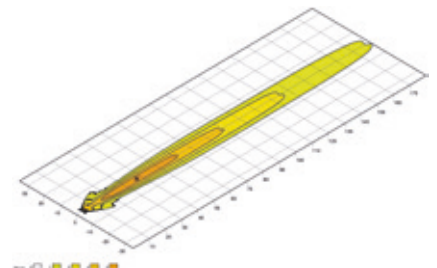

Spot illumination

Recommended tilt angle: 12°, far: 5°

1G0 996 276-...	-451	-481	-631	-701	...996 376-001	...996 376-501
Voltage	9 – 33 V	9 – 33 V	9 – 33 V	9 – 33 V	9 – 33 V	9 – 16 V
Close-range illumination	X	X	X	-	-	X
Long-range illumination	-	-	-	X	X	-
Spot illumination	-	-	-	-	-	-
Energy consumption	13 W	13 W	13 W	13 W	13 W	13 W
Lumen (hot)	800 lm	800 lm	800 lm	800 lm	800 lm	800 lm
Electrical connection	2,000 mm cable	200 mm cable and DT connector	3,500 mm spiral cable with cigarette connection	2,000 mm cable	2,000 mm cable	2,000 mm cable
Upright mounting	X	X	X	X	X	X
Suspended mounting	X	X	X	X	X	X
Mounting, lateral	-	-	-	-	-	-
Bracket width	36 mm	36 mm	36 mm	36 mm	36 mm	36 mm
Other features	-	Extra-wide illumination	Magnetic base	Spot illumination, blue lens	Spot illumination	Thermo Pro housing, hinge

## Mega Beam LED Gen. IV

### Product features

- Classic design
- Simple conversion thanks to modular design
- Also available with a handle



### Technical details

Light output (measured): 2,500 lumen, power requirement: 30 watts, colour temperature: 6,500°Kelvin, multivolt, polarity reversal protection, overvoltage protection, thermal management, IP 6K9K / IP 6K8 (pressure cleaner-proof / submersible), ECE-R10-approved, high-quality aluminium housing

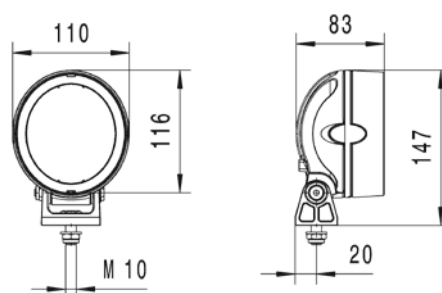

### Illumination

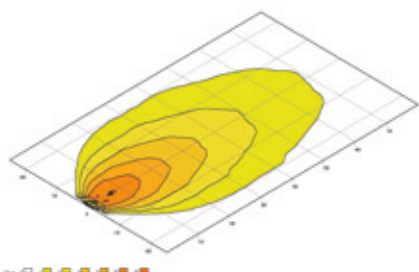

Close-range illumination

Recommended tilt angle | Close-range: 12°

1GM 996 136-...	-501	-511	-521
Voltage	9 – 33 V	9 – 33 V	9 – 33 V
Close-range illumination	X	X	X
Long-range illumination	-	-	-
Spot illumination	-	-	-
Energy consumption	30 W	30 W	30 W
Lumen (hot)	2,500 lm	2,500 lm	2,500 lm
Electrical connection	2,000 mm cable	2,000 mm cable	2,000 mm cable
Upright mounting	X	-	X
Suspended mounting	-	X	-
Mounting, lateral	-	-	-
Bracket width	42 mm plastic bracket	42 mm plastic bracket	42 mm plastic bracket
Other features	-	-	with handle

## Mega Beam LED Gen. III

### Product features

- Classic design with innovative LED technology
- Ideal for battery-powered vehicles or already heavily stressed generators



### Technical details

Light output (measured): 800 lumen, power requirement: 13 watts, colour temperature: 6,500°Kelvin, multivolt, polarity reversal protection, overvoltage protection, thermal management, IP 6K9K / IP 6K8 (pressure cleaner-proof / submersible), ECE-R10-approved, high-quality aluminium housing

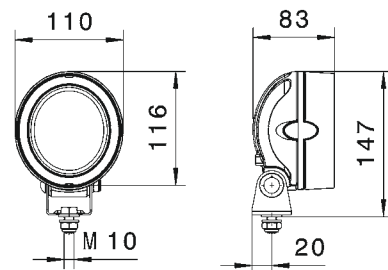

### Illumination

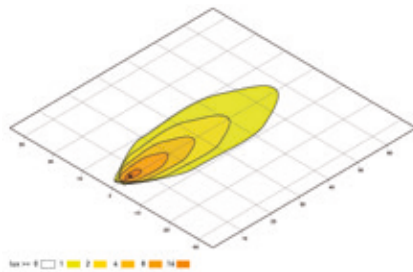

Close-range illumination

Recommended tilt angle: 12°

1GM 996 136-...	-311	-361
Voltage	9 – 33 V	9 – 33 V
Close-range illumination	X	X
Long-range illumination	-	-
Spot illumination	-	-
Energy consumption	13 W	13 W
Lumen (hot)	800 lm	800 lm
Electrical connection	2,000 mm cable	2,000 mm cable
Upright mounting	X	-
Suspended mounting	-	X
Mounting, lateral	-	-
Bracket width	42 mm	42 mm
Other features	-	-

# Power Beam 3000

## Product features

- Robust LED work light with an extra-high light output for high-performance use. Even outperforms comparable xenon models
- Homogenous illumination for optimum visibility



## Technical details

Light output (measured): 3,000 lumen, power requirement: 43 watts, colour temperature: 6,500°Kelvin, multivolt, polarity reversal protection, overvoltage protection, thermal management, IP 6K9K / IP 6K8 (pressure cleaner-proof / submersible), ECE-R10-approved, robust aluminum housing, GERMAN plug variant ADR/GGVSEB-tested

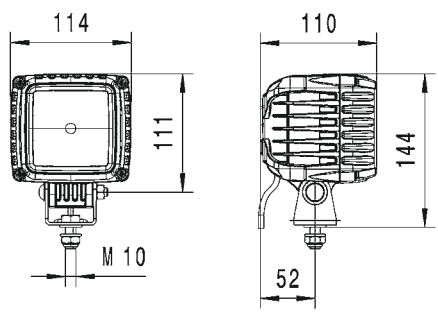

## Illumination

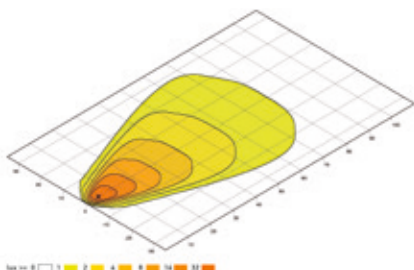

Close-range illumination

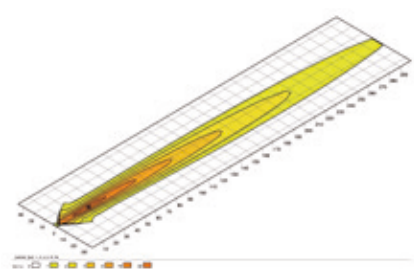

Long-range illumination

Recommended tilt angle: 12°, far: 3°

1GA 996 192-...	-001	-011	-021	-051	-061
Voltage	9 – 33 V	9 – 33 V	9 – 33 V	9 – 33 V	9 – 33 V
Close-range illumination	X	-	X	X	X
Long-range illumination	-	X	-	-	-
Spot illumination	-	-	-	-	-
Energy consumption	43 W	43 W	43 W	43 W	43 W
Lumen (hot)	3,000 lm	3,000 lm	3,000 lm	3,000 lm	3,000 lm
Electrical connection	2,000 mm cable	2,000 mm cable	2,000 mm cable	Mounting plate according to DIN EN ISO 4165	DT connector
Upright mounting	X	X	X	X	X
Suspended mounting	X	X	X	X	X
Mounting, lateral	-	-	-	-	-
Bracket width	42 mm	42 mm	119 mm	119 mm	42 mm
Other features	-	-	Heavy Duty, Surrounding bracket	With handle, pipe socket fixing	ADR / GGVSEB-tested





## Power Beam 1800

### Product features

- Compact dimensions allow versatile use
- 40% more luminous efficiency than the former Power Beam 1500
- Also available with CoroSafe coating for really tough conditions

### Technical details

Light output (measured): 1,850 lumen, power requirement: 36 watts, colour temperature: 6,500°Kelvin, single voltage (12 or 24 volts), polarity reversal protection, overvoltage protection, thermal management, IP 6K9K / IP 6K8 (pressure cleaner-proof / submersible), ECE-R10-approved, high-quality aluminium housing

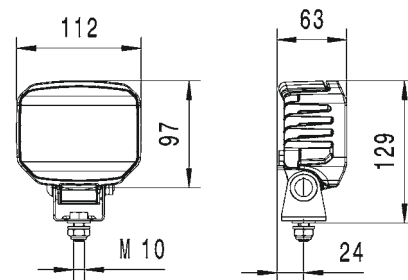

### Illumination

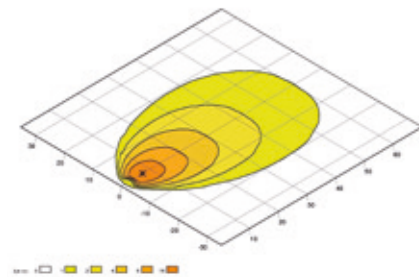

Close-range illumination

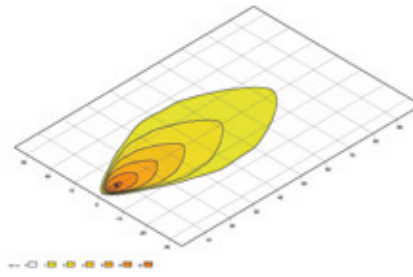

Long-range illumination

### SPECIAL:

Dimming possible thanks to the adjustable duty cycle of the pulse-width-modulated signal (PWM). This can be facilitated by integrating a conventional LED PWM dimmer into the supply line. (max. light input voltage 1.5 A ; frequency 100 – 1,000 Hz)

Recommended tilt angle: 12°, far: 5°



1GA 996 388-...	-001	-011	-021	-031	-041
Voltage	12 V	24 V	12 V	24 V	24 V
Close-range illumination	X	X	-	-	-
Long-range illumination	-	-	X	X	X
Spot illumination	-	-	-	-	-
Energy consumption	36 W	36 W	36 W	36 W	36 W
Lumen (hot)	1,850 lm	1,850 lm	1,850 lm	1,850 lm	1,850 lm
Electrical connection	DT connector	DT connector	DT connector	DT connector	DT connector
Upright mounting	X	X	X	X	X
Suspended mounting	X	X	X	X	X
Mounting, lateral	-	-	-	-	-
Bracket width	42 mm	42 mm	42 mm	42 mm	42 mm plastic bracket
Other features	Dimming function	Dimming function	Dimming function	Dimming function	Dimming function, CoroSafe coating

## Power Beam 1500

### Product features

- Combines excellent LED light output with a compact design
- With heavy-duty bracket for tough uses and extreme vibration



### Technical details

Light output (measured): 1,300 lumen, power requirement: 22 watts, colour temperature: 6,500°Kelvin, multivolt, polarity reversal protection, overvoltage protection, thermal management, IP 6K9K / IP 6K8 (pressure cleaner-proof / submersible), ECE-R10-approved, high-quality aluminium housing, ADR/GGVSEB-tested

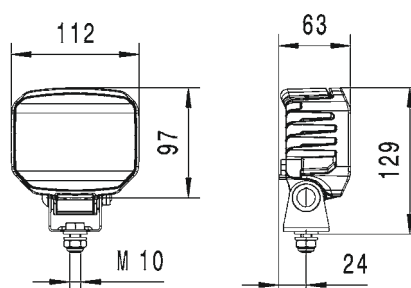

### Illumination

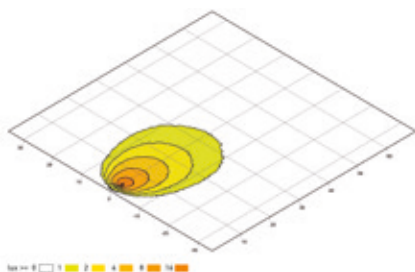

Close-range illumination

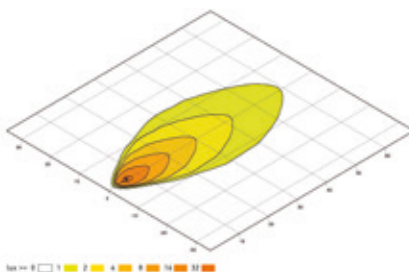

Long-range illumination

Recommended tilt angle: 12°, far: 5°

1GA 996 288-...	-001	-011	-021	-031	-041
Voltage	9 – 33 V	9 – 33 V	9 – 33 V	9 – 33 V	9 – 33 V
Close-range illumination	–	X	–	X	–
Long-range illumination	X	–	X	–	X
Spot illumination	–	–	–	–	–
Energy consumption	22 W	22 W	22 W	22 W	22 W
Lumen (hot)	1,300 lm	1,300 lm	1,300 lm	1,300 lm	1,300 lm
Electrical connection	DT connector	DT connector	DT connector	DT connector	DT connector
Upright mounting	X	X	X	X	X
Suspended mounting	X	X	X	X	X
Mounting, lateral	–	–	–	–	–
Bracket width	42 mm	42 mm	116 mm	116 mm	42 mm
Other features	–	–	Heavy Duty, Surrounding bracket	Heavy Duty, Surrounding bracket	Orange lens

## Modul 90 LED

### Product features

- Greater light output than comparable Xenon worklights
  - Extremely wide, homogenous illumination
  - Excellent value for money
- Modul 90 LED installation version:  
 1G0 996 263-501 (close-range),  
 1G0 996 263-511 (long-range illumination)



### Technical details

Light output (measured): 3,400 lumen, power requirement: 36 watts, colour temperature: 6,500°Kelvin, multivolt, polarity reversal protection, overvoltage protection, thermal management, IP 6K9K / IP 6K8 (pressure cleaner-proof / submersible), ECE-R10-approved, high-quality aluminium housing

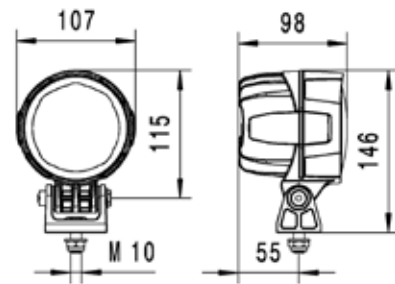

### Illumination

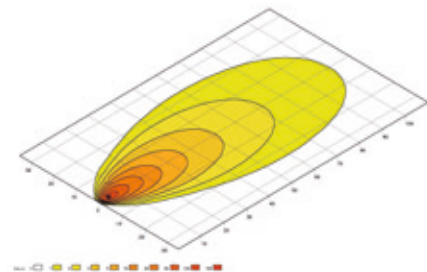

Close-range illumination

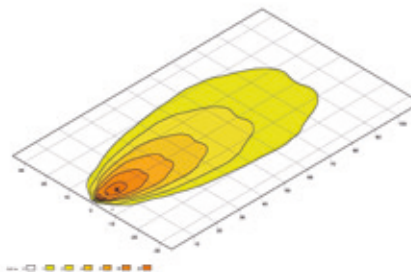

Long-range illumination

Recommended tilt angle: 12°, far: 5°

1G0 996 263-...	-031	-051
Voltage	9 – 33 V	9 – 33 V
Close-range illumination	X	-
Long-range illumination	-	X
Spot illumination	-	-
Energy consumption	36 W	36 W
Lumen (hot)	2,700 lm	2,700 lm
Electrical connection	DT connector	DT connector
Upright mounting	X	X
Suspended mounting	X	X
Mounting, lateral	-	-
Bracket width	42 mm	42 mm
Other features	-	-

## Oval 90 LED Gen. II

### Product features

- Work lights with sleek oval design
- Extra-wide-beam illumination
- Light output that leaves nothing to be desired



### Technical details

Light output (measured): 4,300 lumen, power requirement: 60 watts, colour temperature: 6,500°Kelvin, multivolt, polarity reversal protection, overvoltage protection, thermal management, IP 6K9K / IP 6K8 (pressure cleaner-proof / submersible), ECE-R10-approved, high-quality aluminum housing, ADR/GGVSEB on request

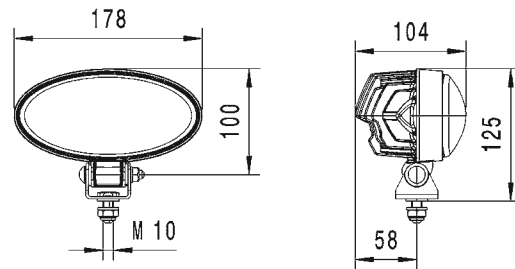

### Illumination

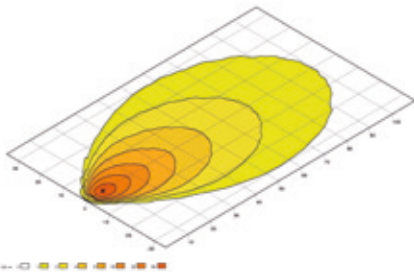

Close-range illumination

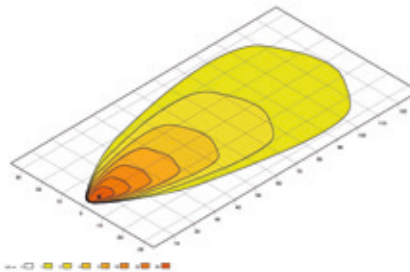

Long-range illumination

Recommended tilt angle | Close-range: 12°, long-range: 5°

1GB 996 486-...	-001	-011
Voltage	9 – 33 V	9 – 33 V
Close-range illumination	X	-
Long-range illumination	-	X
Spot illumination	-	-
Energy consumption	60 W	60 W
Lumen (hot)	4,300 lm	4,300 lm
Electrical connection	DT connector	DT connector
Upright mounting	X	X
Suspended mounting	X	X
Mounting, lateral	-	-
Bracket width	36 mm	36 mm
Other features	-	-



## Oval 90 LED

### Product features

- LED work lights with modern, attractive design
- Xenon-quality light output
- Extra-wide-beam, homogenous illumination



### Technical details

Light output (measured): 2,000 lumen, power requirement: 28 watts, colour temperature: 6,500°Kelvin, multivolt, polarity reversal protection, overvoltage protection, thermal management, IP 6K9K / IP 6K8 (pressure cleaner-proof / submersible), ECE-R10-approved, high-quality aluminium housing, ADR/GGVSEB-tested

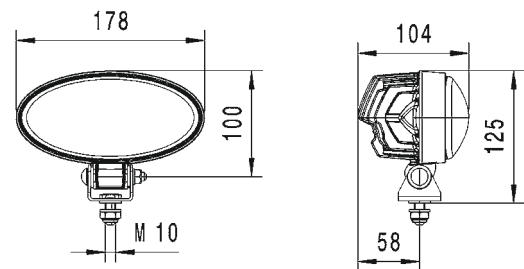

### Illumination

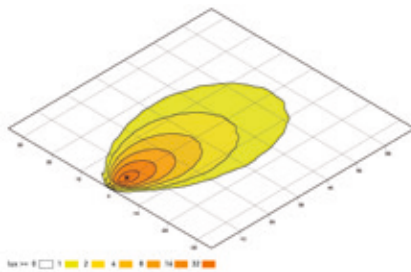

Close-range illumination

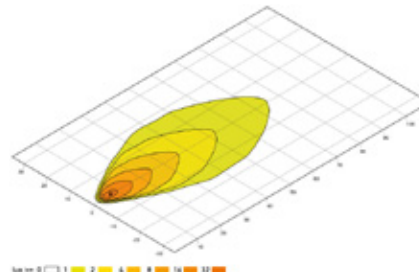

Long-range illumination

Recommended tilt angle: Close-range: 12°, long-range: 5°

1GB 996 386-...	-001	-021
Voltage	9 – 33 V	9 – 33 V
Close-range illumination	X	-
Long-range illumination	-	X
Spot illumination	-	-
Energy consumption	28 W	28 W
Lumen (hot)	2,000 lm	2,000 lm
Electrical connection	DT connector	DT connector
Upright mounting	X	X
Suspended mounting	X	X
Mounting, lateral	-	-
Bracket width	36 mm	36 mm
Other features	-	-

## Oval 100 LED Gen. II

### Product features

- Work lights with compact oval design
- Higher light output than an equivalent xenon work light
- Simple conversion from halogen to LED thanks to modular design



### Technical details

Light output (measured): 4,000 lumen, power requirement: 56 watts, colour temperature: 6,500°Kelvin, multivolt, polarity reversal protection, overvoltage protection, thermal management, IP 6K9K / IP 6K8 (pressure cleaner-proof / submersible), ECE-R10-approved, high-quality aluminium housing, ADR/GGVSEB on request

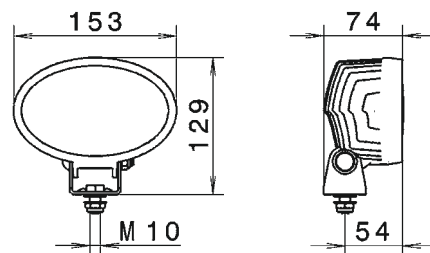

### Illumination

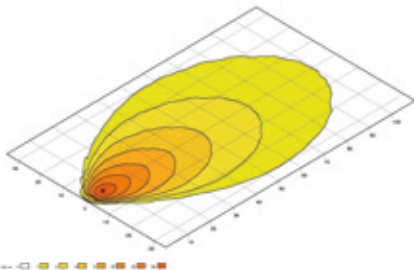

Close-range illumination

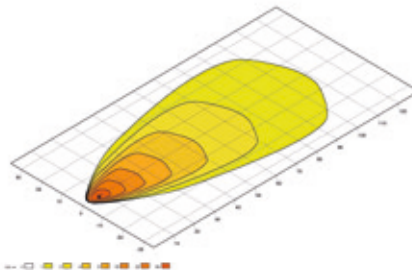

Long-range illumination

Recommended tilt angle | Close-range: 12°, long-range: 5°

1GA 996 761-...	-001	-011
Voltage	9 – 33 V	9 – 33 V
Close-range illumination	X	-
Long-range illumination	-	X
Spot illumination	-	-
Energy consumption	56 W	56 W
Lumen (hot)	4,000 lm	4,000 lm
Electrical connection	DT connector	DT connector
Upright mounting	X	X
Suspended mounting	X	X
Mounting, lateral	-	-
Bracket width	42 mm	42 mm
Other features	-	-

## Oval 100 LED

### Product features

- Versatile LED work light
- Wide, homogenous illumination
- Simple fitting



### Technical details

Light output (measured): 1,700 lumen, power requirement: 25 watts, colour temperature: 6,500°Kelvin, multivolt, polarity reversal protection, overvoltage protection, thermal management, IP 6K9K / IP 6K8 (pressure cleaner-proof / submersible), ECE-R10-approved, high-quality aluminium housing, ADR/GGVSEB-tested

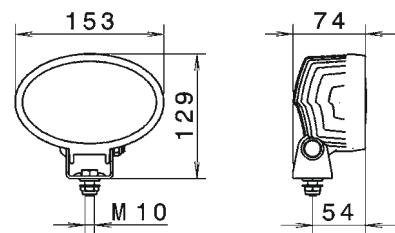

### Illumination

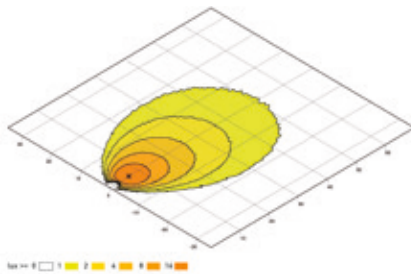

Close-range illumination

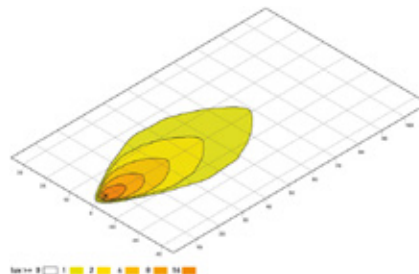

Long-range illumination

Recommended tilt angle: 12°, far: 5°

1GA 996 661-...	-001	-011
Voltage	9 – 33 V	9 – 33 V
Close-range illumination	X	-
Long-range illumination	-	X
Spot illumination	-	-
Energy consumption	25 W	25 W
Lumen (hot)	1,700 lm	1,700 lm
Electrical connection	DT connector	DT connector
Upright mounting	X	X
Suspended mounting	X	X
Mounting, lateral	-	-
Bracket width	42 mm	42 mm
Other features	-	-

## Oval 100 LED TP

### Product features

- Lateral hinge for flexible mounting
- Thermo Pro plastic housing
- Suitable for mounting on mirror arm



### Technical details

Light output (measured): 1,700 lumen, power requirement: 25 watts, colour temperature: 6,500°Kelvin, multivolt, polarity reversal protection, overvoltage protection, thermal management, IP 6K9K / IP 6K8 (pressure cleaner-proof / submersible), ECE-R10-approved

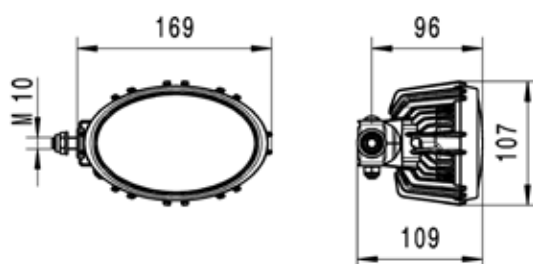

### Illumination

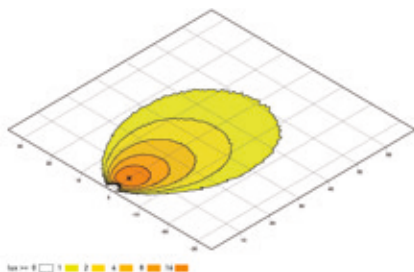

Close-range illumination

Recommended tilt angle | Close-range: 12°

1GA 996 661-...	-031	-041	-501
Voltage	9 – 33 V	9 – 33 V	9 – 33 V
Close-range illumination	X	X	X
Long-range illumination	-	-	-
Spot illumination	-	-	-
Energy consumption	25 W	25 W	25 W
Lumen (hot)	1,700 lm	1,700 lm	1,700 lm
Electrical connection	DT connector	DT connector	DT connector
Upright mounting	-	X	X
Suspended mounting	-	X	X
Mounting, lateral	X	-	-
Bracket width	42 mm	42 mm	42 mm
Other features	Lateral swivel mounting	-	Hinge underneath



## Q90 compact LED

### Product features

- The perfect replacement for an old halogen work light
- Thermo Pro housing for total corrosion resistance
- Suitable for universal use thanks to compact design



### Technical details

Light output (measured): 1,000 lumen, power requirement: 15 watts, colour temperature: 6,500°Kelvins, multivolt, polarity reversal protection, overvoltage protection, thermal management, IP 6K9K / IP 6K8 (pressure cleaner-proof / submersible), ECE-R10-approved

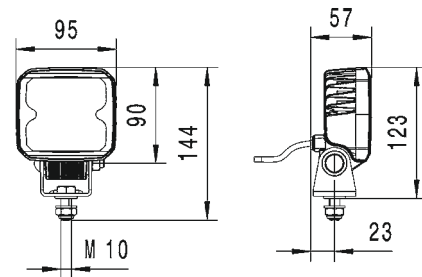

### Illumination

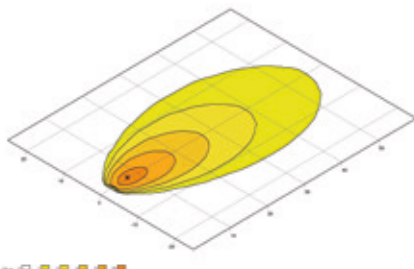

Close-range illumination

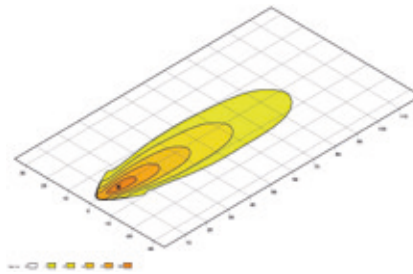

Long-range illumination

Recommended tilt angle | Close-range: 12°, long-range: 5°

1GA 996 284-...	-002	-012	-081	-091
Voltage	9 – 33 V	9 – 33 V	9 – 33 V	9 – 33 V
Close-range illumination	X	–	X	–
Long-range illumination	–	X	–	X
Spot illumination	–	–	–	–
Energy consumption	15 W	15 W	15 W	15 W
Lumen (hot)	1,000 lm	1,000 lm	1,000 lm	1,000 lm
Electrical connection	500 mm cable	500 mm cable	150 mm cable and DT connector	150 mm cable and DT connector
Upright mounting	X	X	X	X
Suspended mounting	X	X	X	X
Mounting, lateral	–	–	–	–
Bracket width	42 mm	42 mm	42 mm	42 mm
Other features	Stylish packaging	Stylish packaging	ADR / GGVSEB-tested	ADR / GGVSEB-tested

# Flat Beam 1000

## Product features

- Extremely flat design
- Excellent corrosion resistance with synthetic material housing
- Highly efficient worklight (only 11 watts)



## Technical details

Light output (measured): 1,100 lumen, power requirement: 11 watts, colour temperature: 6,500°Kelvin, multivolt, polarity reversal protection, overvoltage protection, thermal management, IP 6K9K / IP 6K8 (pressure cleaner-proof / submersible), ECE-R10-approved, impact-resistant plastic housing

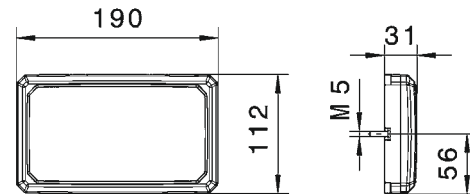

## Illumination

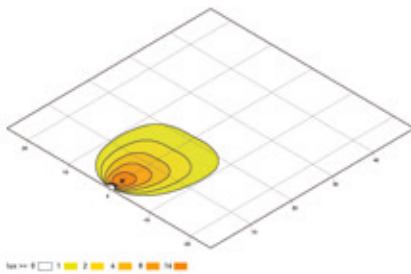

Close-range illumination

*e.g. for the rear panel of CV cabs!*

Recommended tilt angle: standard version: 12° and 1GD 996 193-051: 0° (45° illumination with special lens)

1GD 996 193-...	-001	-011	-051
Voltage	9 – 33 V	9 – 33 V	9 – 33 V
Close-range illumination	X	X	X
Long-range illumination	-	-	-
Spot illumination	-	-	-
Energy consumption	11 W	11 W	11 W
Lumen (hot)	1,100 lm	1,100 lm	1,100 lm
Electrical connection	2,000 mm cable	2,000 mm cable	2,000 mm cable
Upright mounting	X	X	X
Suspended mounting	-	-	-
Mounting, lateral	-	-	-
Bracket width	-	-	-
Other features	Wall-mounted	Surrounding bracket	45° illumination



## Flat Beam 500

### Product features

- Excellent corrosion resistance with synthetic material housing
- Extremely flat design
- The 45° illumination pours light onto the nearby work area with no need to tilt

### Technical details

Light output (measured): 550 lumen, power requirement: 7 watts, colour temperature: 6,500°Kelvin, multivolt, polarity reversal protection, overvoltage protection, thermal management, IP 6K9K / IP 6K8 (pressure cleaner-proof / submersible), ECE-R10-approved, impact-resistant plastic housing, 45° illumination as standard

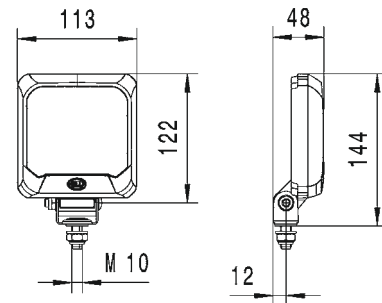

### Service light – Flat Beam 500



If machinery fails at night, the only way to perform repairs is often by using a portable lamp. However, having both hands free is a key advantage when it comes to getting the vehicle operational again as quickly as possible. The Flat Beam 500 is perfect in this situation. Installation on the inside of the side combine harvester flap offers good visibility of the entire engine compartment and guarantees safe work on the vehicle.

Recommended tilt angle: 0°

1GA 995 193-...	-001	-011	-021	-031	-041
Voltage	9 – 33 V	9 – 33 V	9 – 33 V	9 – 33 V	9 – 33 V
Close-range illumination	X	X	X	X	X
Long-range illumination	-	-	-	-	-
Spot illumination	-	-	-	-	-
Energy consumption	7 W	7 W	7 W	7 W	7 W
Lumen (hot)	550 lm	550 lm	550 lm	550 lm	550 lm
Electrical connection	2,000 mm cable	2,000 mm cable	2,000 mm cable	2,000 mm cable	2,000 mm cable
Upright mounting	X	-	X	X	X
Suspended mounting	-	X	-	-	-
Mounting, lateral	-	-	-	-	-
Bracket width	36 mm	36 mm	36 mm	36 mm	36 mm
Other features	Standard holder	Standard holder	Wall-mounted	Lug mounting	Surrounding bracket

## Modul 50 LED

### Product features

- Ultra-compact worklight
- Sturdy housing
- Limited installation space required



### Technical details

Light output (measured): 800 lumen, power requirement: 15 watts, colour temperature: 6,500°Kelvin, multivolt, polarity reversal protection, overvoltage protection, thermal management, IP 6K9K / IP 6K8 (pressure cleaner-proof / submersible), ECE-R10-approved, high-quality aluminium housing, ADR/GGVSEB-tested

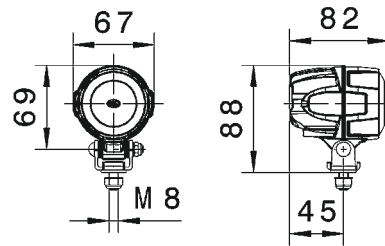

### Illumination

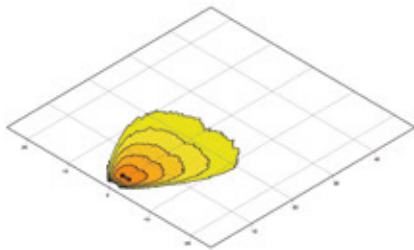

Close-range illumination

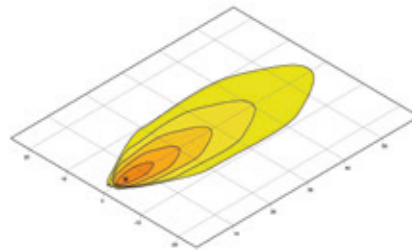

Long-range illumination

Recommended tilt angle: 12°, far: 5°

1G0 995 050-...	-001	-011	-021
Voltage	9 – 48 V	9 – 48 V	9 – 48 V
Close-range illumination	X	X	-
Long-range illumination	-	-	X
Spot illumination	-	-	-
Energy consumption	15 W	15 W	15 W
Lumen (hot)	800 lm	800 lm	800 lm
Electrical connection	DT connector	DT connector	DT connector
Upright mounting	X	-	X
Suspended mounting	-	X	X
Mounting, lateral	-	-	-
Bracket width	27 mm	27 mm	27 mm
Other features	-	-	-



## Modul 50 LED – Color spot

### Product features

- Special use as a warning light
- Punctiform illumination on the ground
- Increases working safety
- Available in various colours



### Technical details

Power requirement: 15 watts, multivolt, polarity reversal protection, overvoltage protection, thermal management, IP 6K9K / IP 6K8 (pressure cleaner-proof / submersible), ECE-R10-approved, high-quality aluminium housing, ADR/GGVSEB tested

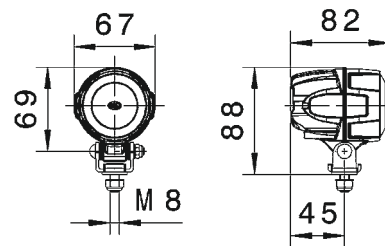

### Illumination



1G0 995 050-...	-051	-061	-071	-081
Voltage	9 – 52 V	9 – 52 V	9 – 52 V	9 – 52 V
Close-range illumination	-	-	-	-
Long-range illumination	-	-	-	-
Spot illumination	X	X	X	X
Energy consumption	15 W	15 W	15 W	15 W
Lumen (hot)	-	-	-	-
Electrical connection	DT connector	DT connector	DT connector	DT connector
Upright mounting	X	X	X	X
Suspended mounting	X	X	X	X
Mounting, lateral	-	-	-	-
Bracket width	27 mm	27 mm	27 mm	27 mm
Other features/colour	White	Blue	Green	Red

## LED Light Bar 350

### Product features

- Suitable for mounting on the roof thanks to low profile
- Extra-wide-beam illumination for close-range use
- Completely corrosion-resistant thanks to the Thermo Pro plastic housing

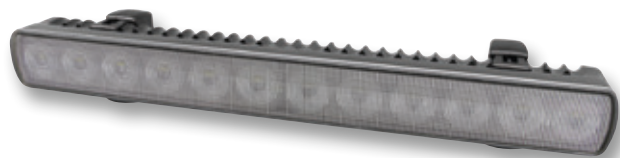

### Technical details

Light output (measured): 2,200 lumen, power requirement: 25 watts, colour temperature: 5,000°Kelvin, multivolt, polarity reversal protection, overvoltage protection, thermal management, IP 6K9K / IP 6K7 (pressure cleaner-proof / submersible), ECE-R10-approved

### Illumination

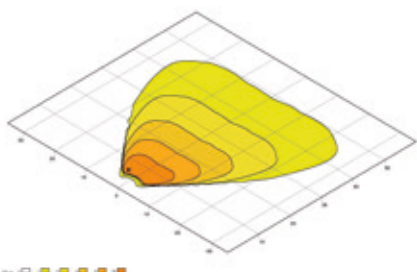

Close-range illumination

Recommended tilt angle: 12°

1GJ 958 040-...	-501
Voltage	9 – 33 V
Close-range illumination	X
Long-range illumination	-
Spot illumination	-
Energy consumption	25 W
Lumen (hot)	2,200 lm
Electrical connection	2,500 mm cable
Upright mounting	X
Suspended mounting	X
Mounting, lateral	-
Bracket width	Flexible
Other features	-

## LED Light Bar 350 accessories

### 1. Universal bracket – 8HG 958 139-841

HELLA is extending its range of accessories for the Light Bar 350 with this new and easy-to-mount fixing bracket, which can be used universally. The brackets simply click into place on the ends of the headlamp housing. Their mounting is very flexible, and they can be fixed onto all mounting surfaces. As a result, they lend themselves perfectly to most mounting configurations.

The new universal bracket can be used for both auxiliary headlamps and work lights. All nuts, screws and brackets are made from marine-grade stainless steel. The new bracket – with its anti-theft screw cap device – offers continuously variable adjustment. The universal bracket set can also be used as a spare parts set for the LED Light Bar 470.

#### Delivery scope:

- 2 x stainless steel mounting brackets
- 2 x stainless steel M8 x 20 mm hexagon socket screws
- 2 x stainless steel/nylon M8 lock nuts
- 2 x end adaptors
- 2 x friction washers
- 2 x end clamps
- 2 x screw caps



The mounting brackets can be positioned to suit most mounting positions.



They are also ideal for mounting on angled surfaces.

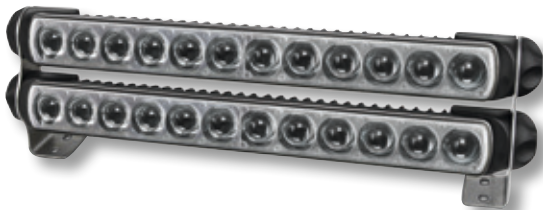

### 2. Bracket for double mounting – 8HG 958 128-811

The new, easy-to-mount bracket component from HELLA for the Light Bar 350 and 470 allows double mounting of auxiliary headlamps or work lights.

Two headlamps can be positioned above one another and adjusted individually. This enables perfect alignment, and they also allow illumination to be adjusted to individual requirements.

#### Delivery scope:

- 2 x stainless steel double mounting brackets
- (for combination with 8HG 958 139-071)



Mounting brackets allow continuously variable illumination adjustment.

## Halogen work lights





# Picador

## Product features

- Timeless, classic worklight
- Wide close-range illumination
- Pivot joint for ideal light adjustment



## Technical details

Light output: 1,150/1,400 lumen, colour temperature: 2,500° Kelvin, impact-resistant, glass-fibre-reinforced plastic housing, IP 5K9K (pressure cleaner-proof)

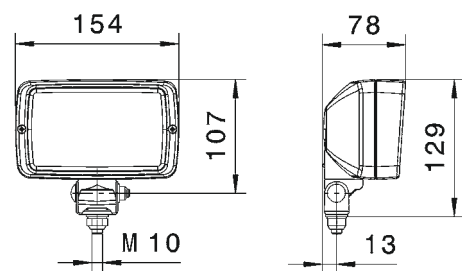

## Illumination

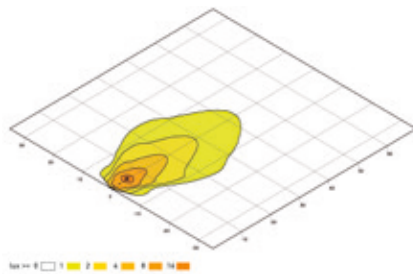

Close-range illumination

Recommended tilt angle: 12°

1GA ...	... 006 876-001*	... 998 522-011*	... 006 875-001*
Voltage	12 / 24 V	12 / 24 V	12 / 24 V
Close-range illumination	X	X	X
Long-range illumination	-	-	-
Spot illumination	-	-	-
Energy consumption	55 / 70 W	55 / 70 W	55 / 70 W
Lumen (hot)	1,150 / 1,400 lm	1,150 / 1,400 lm	1,150 / 1,400 lm
Electrical connection	Cable inlet with grommet	Cable inlet with grommet	Cable inlet with grommet
Upright mounting	X	X	-
Suspended mounting	X	X	-
Mounting, lateral	-	-	X
Bracket width	36 mm	36 mm	36 mm
Other features	Swivel joint	-	Mounting on the side

\* Without bulb

## Ultra Beam

### Product features

- The classic among work lights
- The most popular work light on the market
- Suitable for universal use thanks to compact design



### Technical details

Light output: 1,150/1,400 lumen, colour temperature: 2,500° Kelvin, impact-resistant glass fibre-reinforced synthetic material housing, IP 5K9K (pressure cleaner-proof), GGVSEB/ADR tested

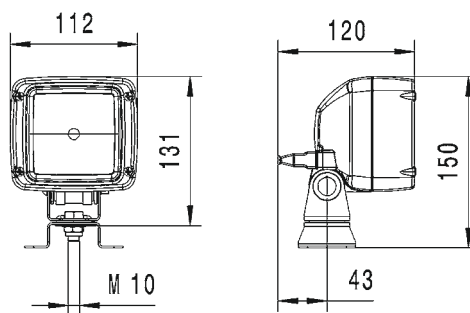

### Illumination

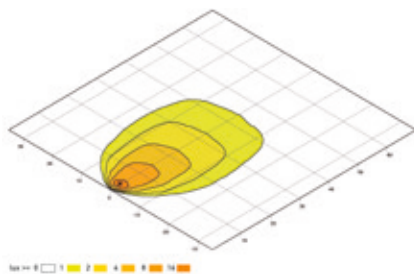

Close-range illumination

Recommended tilt angle: 15°, far: 5°

1GA 007 506-...	-001*	-011*	-081*	-391*	...996 150-081
Voltage	12 / 24 V	12 / 24 V	12 / 24 V	12 / 24 V	12 V
Close-range illumination	X	X	X	X	-
Long-range illumination	-	-	-	-	X
Spot illumination	-	-	-	-	-
Energy consumption	55 / 70 W	55 / 70 W	55 / 70 W	55 / 70 W	65 W
Lumen (hot)	1,150 / 1,400 lm	1,150 / 1,400 lm	1,150 / 1,400 lm	1,150 / 1,400 lm	1,700 lm
Electrical connection	AMP connector	AMP connector	Cable inlet with grommet	DT connector	AMP connector
Upright mounting	X	X	X	X	X
Suspended mounting	X	X	X	X	X
Mounting, lateral	-	-	-	-	-
Bracket width	42 mm	42 mm	42 mm	42 mm	42 mm
Other features	-	Heavy Duty	-	-	incl. H9 bulb

\* Without bulb



## Ultra Beam with handle

### Product features

- The classic among work lights
- Fitted with a handle for better adjustment
- Optionally also available with ON/OFF switch



### Technical details

Light output: 1,150/1,400 lumen, colour temperature: 2,500° Kelvin, impact-resistant glass fibre-reinforced synthetic material housing, IP 5K9K (pressure cleaner-proof)

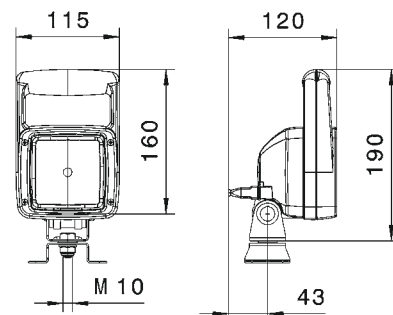

### Illumination

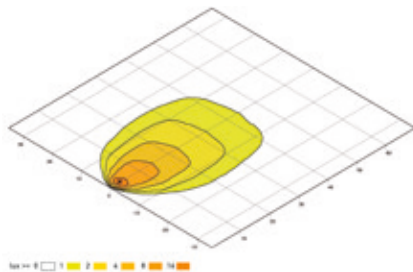

Close-range illumination

Recommended tilt angle: 15°, far: 5°

1GA 007 506-...	-021*	-681	...997 506-631*
Voltage	12 / 24 V	24 V	12 / 24 V
Close-range illumination	X	X	X
Long-range illumination	-	-	-
Spot illumination	-	-	-
Energy consumption	55 / 70 W	70 W	55 / 70 W
Lumen (hot)	1,150 / 1,400 lm	1,400 lm	1,150 / 1,400 lm
Electrical connection	AMP connector	Mounting plate according to DIN EN ISO 4165	AMP connector
Upright mounting	X	X	X
Suspended mounting	X	-	X
Mounting, lateral	-	-	-
Bracket width	42 mm	Tube diameter 24 mm	42 mm
Other features	Heavy Duty	Pipe-socket attachment	Heavy Duty On/off switch

\* Without bulb  
Corresponding Isolux graphs can be found on page 100

## Oval 100 Double Beam

### Product features

- Wide, homogenous illumination of the work area
- 2 bulbs for double the light output
- For universal use



### Technical details

Light output: 2,300 lumen, colour temperature: 2,500 Kelvin, extremely powerful light output with double chamber reflector. IP 5K9K (pressure cleaner-proof), impact-proof, glass-fibre-reinforced plastic housing

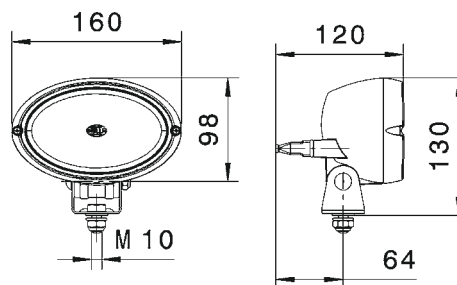

### Illumination

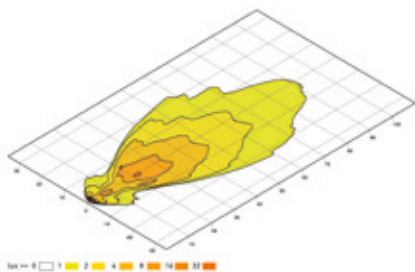

Close-range illumination

Recommended tilt angle: 12°, far: 5°

1GA 996 161-...	-131	-291	...996 361-011
Voltage	12 V	12 V	24 V
Close-range illumination	-	X	-
Long-range illumination	X	-	X
Spot illumination	-	-	-
Energy consumption	110 W	110 W	140 W
Lumen (hot)	2,300 lm	2,300 lm	2,800 lm
Electrical connection	AMP connector	AMP connector	AMP connector
Upright mounting	X	X	X
Suspended mounting	X	X	X
Mounting, lateral	-	-	-
Bracket width	42 mm	42 mm	42 mm
Other features	Double Beam	Double Beam	Double Beam

# Oval 100

## Product features

- Classic work light with oval design
- For universal use
- Wide, homogenous illumination



## Technical details

Light output: 1,150 lumen, colour temperature: 2,500° Kelvin, IP 5K9K (pressure cleaner-proof), impact-resistant, glass-fibre-reinforced plastic housing

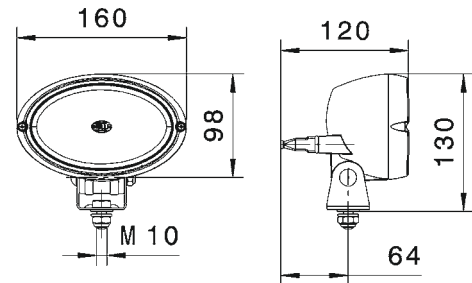

## Illumination

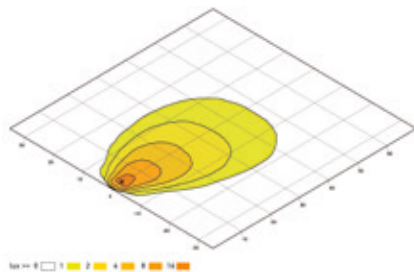

Close-range illumination

Recommended tilt angle: 12°, far: 5°

1GA 996 161-...	-121	-281	-581	-391
Voltage	12 V	12 V	24 V	12 V
Close-range illumination	X	-	X	X
Long-range illumination	-	X	-	-
Spot illumination	-	-	-	-
Energy consumption	55 W	55 W	70 W	65 W
Lumen (hot)	1,150 lm	1,150 lm	1,400 lm	1,700 lm
Electrical connection	AMP connector	AMP connector	AMP connector	2,000 mm cable
Upright mounting	X	X	X	X
Suspended mounting	X	X	X	-
Mounting, lateral	-	-	-	-
Bracket width	42 mm	42 mm	42 mm	42 mm
Other features	-	-	Heavy Duty	H9, Heavy Duty

## Master

### Product features

- Timeless, classic worklight
- Homogeneous close-range illumination
- For universal use



### Technical details

Light output: 1,150/1,400 lumen, colour temperature: 2,500° Kelvin, impact-resistant glass fibre-reinforced synthetic material housing, IP 5K4K (splash-proof)

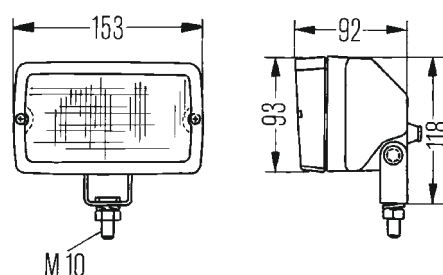

### Illumination

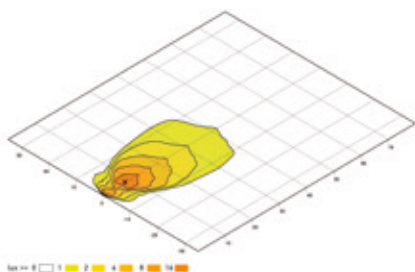

Close-range illumination

Recommended tilt angle: 12°, far: 5°

1GA 005 060-...	-001*	-041*
Voltage	12 / 24 V	12 / 24 V
Close-range illumination	-	X
Long-range illumination	X	-
Spot illumination	-	-
Energy consumption	55 / 70 W	55 / 70 W
Lumen (hot)	1,150 / 1,400 lm	1,150 / 1,400 lm
Electrical connection	Cable inlet with grommet	Cable inlet with grommet
Upright mounting	X	X
Suspended mounting	X	X
Mounting, lateral	-	-
Bracket width	33 mm	33 mm
Other features	-	-

\* Without bulb

## Double Beam

### Product features

- Intensive light thanks to double reflector
- For universal use



### Technical details

Light output: 2,300/2,800 lumen, colour temperature: 2,500° Kelvin, impact-resistant, glass-fiber-reinforced plastic housing, IP 5K4K (splash-proof), GGVSEB/ADR-tested

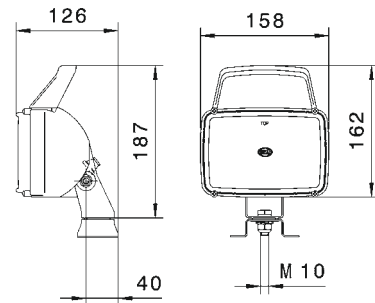

### Illumination

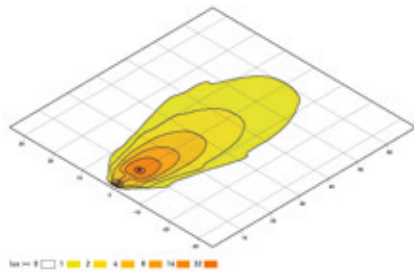

Close-range illumination

Recommended tilt angle: 12°, far: 5°

1GA 006 991-...	-031*	-041*	-051*	-091*
Voltage	12/24 V	12/24 V	12/24 V	12/24 V
Close-range illumination	X	X	-	X
Long-range illumination	-	-	X	-
Spot illumination	-	-	-	-
Energy consumption	110/140 W	110/140 W	110/140 W	110/140 W
Lumen (hot)	2,300/2,800 lm	2,300/2,800 lm	2,300/2,800 lm	2,300/2,800 lm
Electrical connection	250 mm cable	250 mm cable	250 mm cable	250 mm cable
Upright mounting	X	X	X	X
Suspended mounting	X	X	X	X
Mounting, lateral	-	-	-	-
Bracket width	42 mm	42 mm	42 mm	42 mm
Other features	Extra-wide illumination, with handle	Extra-wide illumination	-	-

\* Without bulb

## Modul 70, H9

### Product features

- Compact, round work light
- Blue lens ensures high-contrast light which penetrates dust, water and fog



### Technical details

Light output: 1,700 lumen, colour temperature: 3,200° Kelvin, impact-resistant, glass-fibre-reinforced plastic housing, IP 5K9K (pressure cleaner-proof)

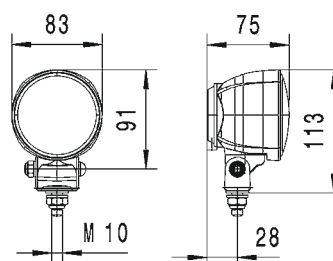

### Illumination

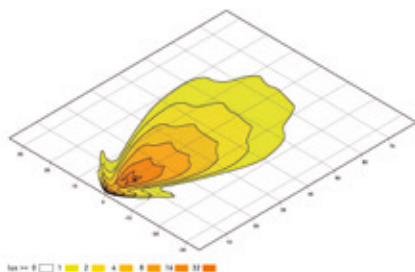

Close-range illumination

Recommended tilt angle: 12°, far: 5°

1G0 996 176-...	-171	-181	-671
Voltage	12 V	12 V	12 V
Close-range illumination	X	X	-
Long-range illumination	-	-	X
Spot illumination	-	-	-
Energy consumption	65 W	65 W	65 W
Lumen (hot)	1,700 lm	1,700 lm	1,700 lm
Electrical connection	2,000 mm cable	2,000 mm cable	H9 connector
Upright mounting	X	-	X
Suspended mounting	-	X	-
Mounting, lateral	-	-	-
Bracket width	36 mm	36 mm	36 mm
Other features	-	-	Blue lens



## Modul 70, H3

### Product features

- HELLA's smallest halogen work light
- Suitable for mounting in tight spaces
- For universal use



### Technical details

Light output: 1,150/1,400 lumen, colour temperature: 2,500° Kelvin, impact-resistant glass fibre-reinforced synthetic material housing, IP 5K9K (pressure cleaner-proof)

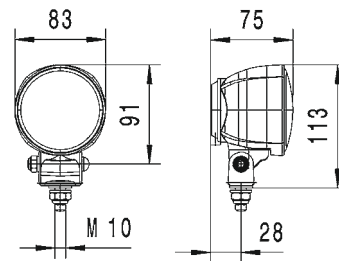

### Illumination

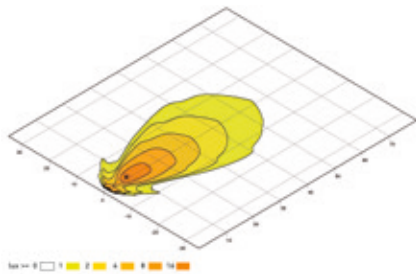

Close-range illumination

Recommended tilt angle: 12°, far: 5°

1G0 996 176-...	-001*	-011*	-111*
Voltage	12 / 24 V	12 / 24 V	12 / 24 V
Close-range illumination	X	-	X
Long-range illumination	-	X	-
Spot illumination	-	-	-
Energy consumption	55 / 70 W	55 / 70 W	55 / 70 W
Lumen (hot)	1,150 / 1,400 lm	1,150 / 1,400 lm	1,150 / 1,400 lm
Electrical connection	Cable inlet with grommet	Cable inlet with grommet	Cable inlet with grommet
Upright mounting	X	X	-
Suspended mounting	-	-	X
Mounting, lateral	-	-	-
Bracket width	36 mm	36 mm	36 mm
Other features	-	-	-

\* Without bulb

## Mega Beam

### Product features

- Modern design
- For universal use
- Excellent illumination into the distance



### Technical details

Light output: 1,150/1,400 lumen, colour temperature: 2,500° Kelvin, impact-resistant, glass-fibre-reinforced plastic housing, IP 5K9K (pressure cleaner-proof; except variant -091), GGVSEB/ADR-tested

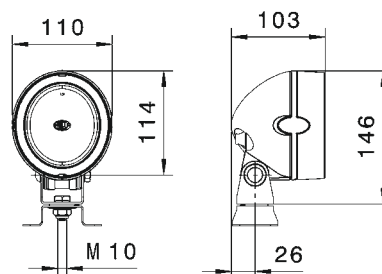

### Illumination

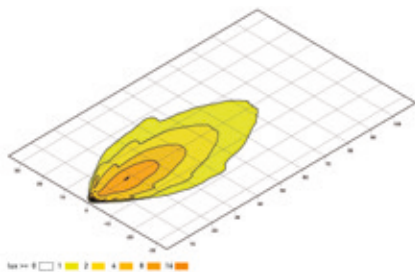

Close-range illumination

Recommended tilt angle: 12°, far: 5°

1GM 996 134-...	-051*	-081*	-171*	-321*	-091*
Voltage	12 / 24 V	12 / 24 V	12 / 24 V	12 / 24 V	12 / 24 V
Close-range illumination	-	-	X	X	-
Long-range illumination	X	X	-	-	X
Spot illumination	-	-	-	-	-
Energy consumption	55 / 70 W	55 / 70 W	55 / 70 W	55 / 70 W	55 / 70 W
Lumen (hot)	1,150 / 1,400 lm	1,150 / 1,400 lm	1,150 / 1,400 lm	1,150 / 1,400 lm	1,150 / 1,400 lm
Electrical connection	Cable inlet with grommet	AMP connector	AMP connector	Cable inlet with grommet	Cable inlet with grommet
Upright mounting	X	X	X	X	-
Suspended mounting	X	X	X	X	-
Mounting, lateral	-	-	-	-	-
Bracket width	42 mm	42 mm	42 mm	42 mm	-
Other features	Heavy Duty	Heavy Duty	Heavy Duty	-	Installation

\* Without bulb

# Matador

## Product features

- Work light with protective grating
- Wide close-range illumination
- Fitted with a handle for better adjustment



## Technical details

Light output: 1,150/1,400 lumen, colour temperature: 2,500° Kelvin, impact-resistant, glass-fibre-reinforced plastic housing, IP 5K4K (splash-proof)

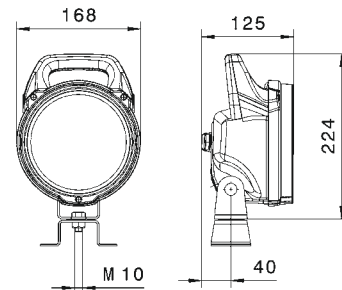

## Illumination

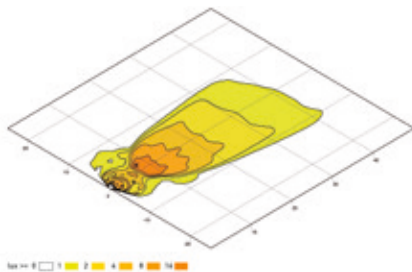

Close-range illumination

Recommended tilt angle: 12°

1G4 003 470-...	-001*	-031*	-051*	-141
Voltage	12 / 24 V	12 / 24 V	12 / 24 V	24 V
Close-range illumination	X	X	X	X
Long-range illumination	-	-	-	-
Spot illumination	-	-	-	-
Energy consumption	55 / 70 W	55 / 70 W	55 / 70 W	70 W
Lumen (hot)	1,150 / 1,400 lm	1,150 / 1,400 lm	1,150 / 1,400 lm	1,400 lm
Electrical connection	Cable inlet with grommet	Cable inlet with grommet	Cable inlet with grommet	DIN EN ISO 4165
Upright mounting	X	X	X	X
Suspended mounting	X	X	X	X
Mounting, lateral	-	-	-	-
Bracket width	52 mm	52 mm	52 mm	Tube diameter 24 mm
Other features	On/off switch	On/off switch, cover mesh	Cover mesh	Pipe socket fixing, cover mesh

\* Without bulb

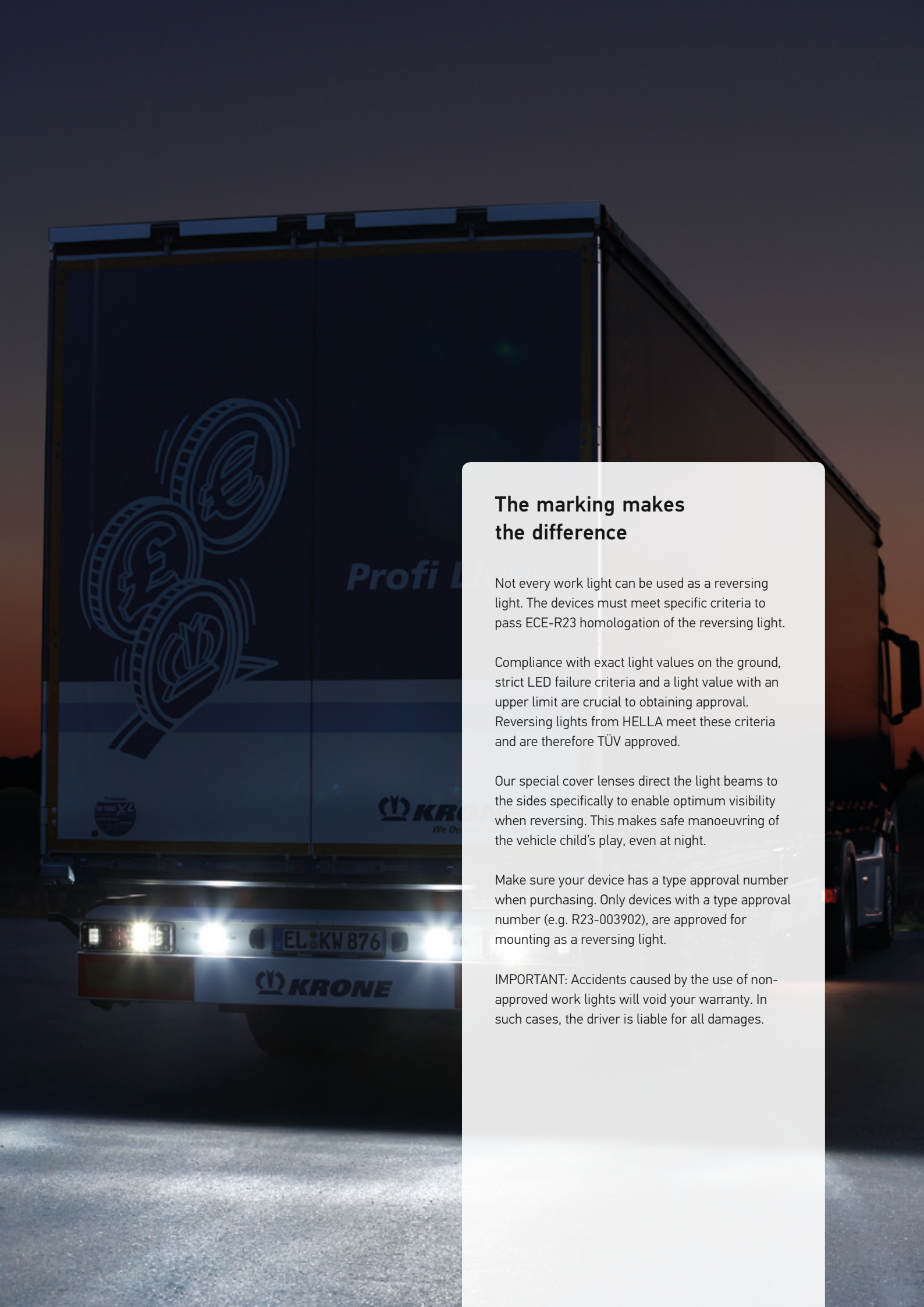

## The marking makes the difference

Not every work light can be used as a reversing light. The devices must meet specific criteria to pass ECE-R23 homologation of the reversing light.

Compliance with exact light values on the ground, strict LED failure criteria and a light value with an upper limit are crucial to obtaining approval. Reversing lights from HELLA meet these criteria and are therefore TÜV approved.

Our special cover lenses direct the light beams to the sides specifically to enable optimum visibility when reversing. This makes safe manoeuvring of the vehicle child's play, even at night.

Make sure your device has a type approval number when purchasing. Only devices with a type approval number (e.g. R23-003902), are approved for mounting as a reversing light.

**IMPORTANT:** Accidents caused by the use of non-approved work lights will void your warranty. In such cases, the driver is liable for all damages.

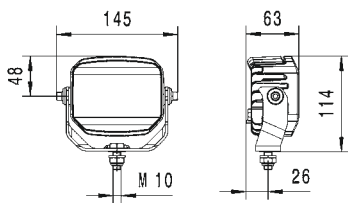

### Power Beam 1000

Light output (measured): 850 lumen, power requirement: 15 watts, colour temperature: 6,500° Kelvin, multivolt, polarity reversal protection, overvoltage protection, thermal management, for heavy-duty use, IP 6K9K / IP 68 (pressure cleaner-proof / submersible), ECE-R10-approved, ECE-R23-approved, high-quality coated aluminium housing (CoroSafe), ADR/GGVSEB-tested

- High corrosion resistance thanks to CoroSafe special coating
- Homogenous light distribution
- High vibration resistance

Tilt angle: according to the installation instructions

2ZR 996 188-...	-121
Voltage	9 – 33 V
Close-range illumination	X
Long-range illumination	-
Energy consumption	15 W
Lumen (hot)	850 lm
Electrical connection	DT connector
Upright mounting	X
Suspended mounting	X
Bracket width	116 mm
Other features	CoroSafe coating

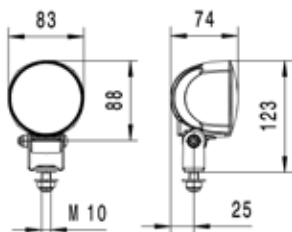

### Modul 70 LED

Light output (measured): 800 lumen, power requirement: 13 watts, colour temperature: 6,500° Kelvin, multivolt, polarity reversal protection, overvoltage protection, thermal management, IP 6K9K / IP 6K8 (pressure cleaner-proof / submersible), ECE-R10-approved, ECE-R23-approved, high-quality aluminium housing

- Compact design
- Special coating with excellent corrosion resistance
- Extra-wide illumination

Tilt angle: according to the installation instructions

2ZR 996 376-...	-091
Voltage	9 – 33 V
Close-range illumination	X
Long-range illumination	-
Energy consumption	13 W
Lumen (hot)	800 lm
Electrical connection	2,000 mm cable
Upright mounting	X
Suspended mounting	X
Bracket width	36 mm
Other features	CoroSafe coating



### Q90 compact LED

Light output (measured): 1,000 lumen, power requirement: 15 watts, colour temperature: 6,500° Kelvin, multivolt, polarity reversal protection, overvoltage protection, thermal management, IP 6K9K / IP 6K8 (pressure cleaner-proof / submersible), ECE-R10-approved.

Approved special lighting as reversing spotlight ECE-R23.

- Excellent corrosion resistance
- Compact design
- Wide-beam, homogenous illumination behind the vehicle

Tilt angle: according to the installation instructions

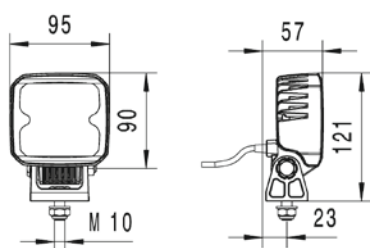

2ZR 996 284-...	-501	-511
Voltage	9 – 33 V	9 – 33 V
Close-range illumination	X	X
Long-range illumination	–	–
Energy consumption	15 W	15 W
Lumen (hot)	1,000 lm	1,000 lm
Electrical connection	2000 mm cable	500 mm cable and DT connector
Upright mounting	X	X
Suspended mounting	X	X
Bracket width	42 mm plastic bracket	42 mm plastic bracket
Other features	–	ADR / GGVSEB-tested



### Repulse Pro

Light output (measured): 700 lumen, power requirement: 11 watts, colour temperature: 5,500° Kelvin, multivolt, reverse polarity protection, overvoltage protection, thermal management, IP 6K9K / IP 67 (pressure cleaner-proof / immersible), ECE-R10 approved, ECE-R23 approved

- Several mounting options
- Highly efficient (only 11 watts)
- Heat-conductive Thermo Pro housing, ADR/GGVSEB-tested

Tilt angle: according to the installation instructions

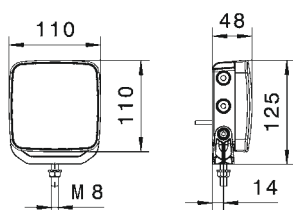

2ZR 012 456-...	-201	-211	-221
Voltage	10 – 30 V	10 – 30 V	10 – 30 V
Close-range illumination	X	X	X
Long-range illumination	–	–	–
Energy consumption	11 W	11 W	11 W
Lumen (hot)	700 lm	700 lm	700 lm
Electrical connection	AMP Superseal connector (2-pole) with 2,000 mm cable	EasyConn connector (2-pole) with 1,000 mm cable	6.3 mm blade terminal sleeves with 3,000 mm cable
Upright mounting	X	X	X
Suspended mounting	X	X	X
Bracket width	86 mm	86 mm	86 mm
Other features	Surrounding bracket for upright, suspended and rear mounting	Surrounding bracket for upright, suspended and rear mounting	Surrounding bracket for upright, suspended and rear mounting



### Flat Beam 500

Light output (measured): 550 lumen, power requirement: 7 watts, colour temperature: 6,500° Kelvin, multivolt, reverse polarity protection, overvoltage protection, thermal management, IP 6K9K / IP 67 (pressure cleaner-proof / immersible), ECE-R10 approved, ECE-R23 approved, impact-resistant synthetic material housing

- Extremely flat design
- Synthetic material housing
- Excellent corrosion resistance
- Highly efficient reversing spotlight (7 watts)

Tilt angle: according to the installation instructions

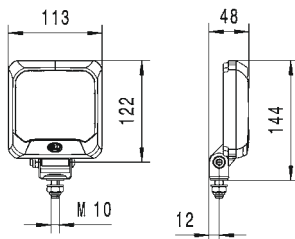

2ZR 995 193-...	-051
Voltage	9 – 33 V
Close-range illumination	X
Long-range illumination	-
Energy consumption	7 W
Lumen (hot)	550 lm
Electrical connection	2,000 mm cable
Upright mounting	X
Suspended mounting	-
Bracket width	36 mm
Other features	Standard holder



### Ultra Beam H3

Reversing spotlight, IP 5K9K (pressure cleaner-proof), impact-proof, glass fibre-reinforced synthetic material housing, approved special illumination as a reversing spotlight, GGVSEB/ADR, colour temperature: 2,300° Kelvin.

Approved special lighting as reversing spotlight ECE-R23.

- Classic design
- Compact design
- Corrosion-resistant

Tilt angle: according to the installation instructions

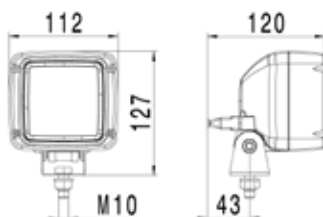

2ZR 997 506-...	-391	-621	-691
Voltage	24 V	24 V	24 V
Close-range illumination	X	-	X
Long-range illumination	-	X	-
Energy consumption	70 W	70 W	70 W
Lumen (hot)	1,400 lm	1,400 lm	1,400 lm
Electrical connection	190 mm cable and AMP connector	190 mm cable and AMP connector	DT connector
Upright mounting	X	X	X
Suspended mounting	-	-	-
Bracket width	42 mm	42 mm	42 mm
Other features	Heavy Duty	Heavy Duty	Heavy Duty



**C220**

Combination headlight with ECE approval IP 5K9K (pressure cleaner-proof), impact-proof, glass fibre-reinforced synthetic material housing.

Horizontal attachment  
Installation below  
H3 / H7 / P21W / T4W

- Compact dimensions
- Illumination without dazzle
- All light functions united in one light

12 V, mounting left with DT connector (6-pole)	<b>1EE 996 174-251</b>
12 V, mounting right with DT connector (6-pole)	<b>1EE 996 174-261</b>

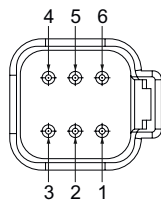
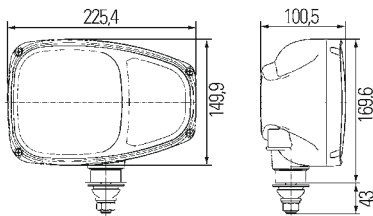

Pin assignment

- 1 – Vacant
- 2 – Low beam
- 3 – High beam
- 4 – Position light
- 5 – Direction indicator
- 6 – Ground



**C220**

Combination headlight with ECE approval IP 5K9K (pressure cleaner-proof), impact-proof, glass fibre-reinforced synthetic material housing.

Horizontal attachment  
Mounting rear  
H3 / H7 / P21W / T4W

- Compact dimensions
- Illumination without dazzle
- All light functions united in one light

12 V, mounting left with DT connector (6-pole)	<b>1EE 996 174-211</b>
12 V, mounting right with DT connector (6-pole)	<b>1EE 996 174-221</b>

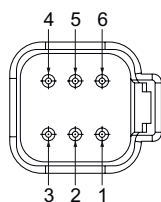
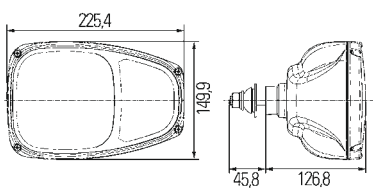

Pin assignment

- 1 – Vacant
- 2 – Low beam
- 3 – High beam
- 4 – Position light
- 5 – Direction indicator
- 6 – Ground





**C140 LED**

Combination headlamp with all functions in LED technology. For horizontal or vertical mounting, with die-cast aluminum housing, lens made of scratch-resistant polycarbonate, with 6-pin DEUTSCH connector, light functions: low and high beam, position light and indicator

9 – 32 V, DT connector (6-pole)

- All light functions in LED
- Outstanding luminous efficiency
- High energy efficiency
- ECE and SAE approval

Vertical attachment, right-hand traffic	1EE 996 374-001
Horizontal attachment left, right-hand traffic	1EE 996 374-011
Horizontal attachment right, right-hand traffic	1EE 996 374-021
Horizontal attachment left, left-hand traffic	1LE 996 374-031
Horizontal attachment right, left-hand traffic	1LE 996 374-041

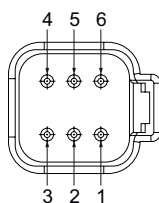
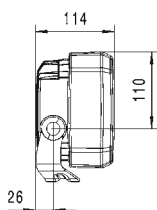
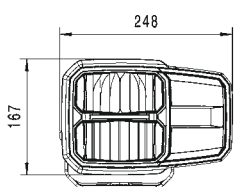

Pin assignment

- 1 – Ground
- 2 – Low beam
- 3 – High beam
- 4 – Position light
- 5 – Direction indicator
- 6 – Status query





### K-LED 2.0

The HELLA K-LED 2.0 ensures the best possible warning effect and therefore optimum safety, since it automatically provides 2.3 times more illumination during the day than at night. It is also the first HELLA beacon that allows you to choose between rotating or flashing warning signals by either simply switching over or programming the required effect. This way, you have the right warning signal to suit every situation or operation.

- Two levels (ECE R-65): beacon with light sensor for automatic switch between day and night mode, for ultimate warning effectiveness
- Functional safety: the first HELLA beacon to meet the requirements of IP 67
- Extremely robust and highly compact

Multivolt 10-32 V, fixed attachment	<b>2XD 011 557-101</b>
Multivolt 10-32 V, airport fixed attachment	<b>2XD 011 557-701</b>
Multivolt 10-32 V, pipe socket fixing	<b>2XD 011 557-201</b>
Multivolt 10-32 V, magnetic mounting bracket	<b>2XD 011 557-301</b>



### Rota LED

The Rota LED with rotating LED light function impresses with its high level of efficiency, its flat and compact design and rotating LED light function. Due to the shock absorbing rubber foot, it is highly resilient to vibration and thus perfectly suited to challenging applications.

- ECE-R65 approved LED beacon with rotating warning signal
- High resistance to vibration and extremely robust
- Extremely efficient

Multivolt 10-32 V, fixed attachment	<b>2RL 010 979-001</b>
Multivolt 10-32 V, flexible pipe socket fixing	<b>2RL 010 979-011</b>
Multivolt 10-32 V, magnetic mounting bracket	<b>2RL 010 979-021</b>



### KLX JuniorPlus

Xenon beacon with high warning effectiveness and good value for money. With stable mounting. Elastic, impact-absorbing base absorbs even heavy impacts and minimizes the danger of damage; the light always returns to the optimum position (maximum inclination: 90°)

- ECE-R65 xenon flash beacon
- Sturdy, easy-to-clean dome
- Flash tubes can be separately replaced

12 V, fixed attachment	2XD 009 051-001
24 V, fixed attachment	2XD 009 051-011
12 V, pipe socket fixing	2XD 009 052-001
24 V, pipe socket fixing	2XD 009 052-011
12 V, magnetic mounting bracket	2XD 009 053-001
24 V, magnetic mounting bracket	2XD 009 053-011



### Rotaflex / Rotafix

The Rotaflex / Rotafix beacon is a compact and resilient rotating beacon. It is characterised by excellent lighting output, an impact-proof light dome, and extremely high resilience to vibration.

- ECE-R65 approved halogen all-round light
- Particularly impact-resistant polycarbonate dome
- Available with elastic, shock-absorbing base – minimises the risk of damage

12 V, fixed attachment	2RL 007 337-001
24 V, fixed attachment	2RL 007 337-011
12 V, pipe socket fixing	2RL 006 846-001
24 V, pipe socket fixing	2RL 006 846-011
12 V, magnetic mounting bracket	2RL 007 337-021
24 V, magnetic mounting bracket	2RL 007 337-031



### Rota Compact

The Rota Compact beacon impresses with premium quality engineering, excellent robustness and light values. Its elastic, impact-absorbing base minimises the danger of damage.

- Especially impact-resistant
- Different attachment versions for every application
- ECE-R65 approved halogen all-round light

12 V, fixed attachment	2RL 009 506-201
24 V, fixed attachment	2RL 009 506-211
12 V, flexible pipe-socket mounting	2RL 009 506-001
24 V, flexible pipe-socket mounting	2RL 009 506-011
12 V, pipe socket fixing	2RL 009 506-101
24 V, pipe socket fixing	2RL 009 506-111

**Bracket**

**Pipe socket fixing bracket**

For combination with socket tubes 8HG 002 365-001. Suitable for mounting with 42 mm bracket width. Electrical contacting within the pipe socket via socket according to DIN 7 2 591.



With AMP connector or grommet

8HG 990 320-001

**Model series:**

Halogen: Ultra Beam, Mega Beam, Oval 100 and Double Beam  
Xenon: AS 200, Oval 100, Ultra Beam

With DEUTSCH or grommet connector

8HG 990 320-011

**Model series:**

LED: Ultra Beam, Oval 100, Power Beam, and Module 90  
Halogen: Ultra Beam

**Mirror bracket attachment**

Rotatable universal holder for mounting on tubes/pipes (diameter: 15-25 mm). For replacement on worklights with 36 mm or 42 mm bracket width.



36 mm bracket width

8HG 990 263-111

**Model series:** Oval 90, Module 70, PowerXen and Flat Beam 500

42 mm bracket width

8HG 990 263-131

**Model series:** Ultra Beam, Mega Beam, Oval 100, Double Beam, AS 200, Power Beam, Module 90, Q90 LED and AP 1200 LED

**Magnetic mounting bracket**

For worklights with U-bracket. Contains 2 magnets and fastening materials.



**Model series:** All work lights with standard bracket and four-point mounting

8HG 004 806-001

**Four-point mounting**

Made of yellow chromed steel



**Model series:** all worklights with standard bracket

9XD 990 298-001

**Four-point mounting**

Made of stainless steel with oblong holes



**Model series:** all worklights with standard bracket

9XD 130 261-001

**Angle bracket**

Angle attachment for worklights with 42 mm bracket width.

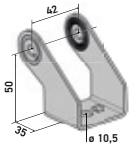

**Model series:** Ultra Beam, Mega Beam, Oval 100, Double Beam, AS 200, Power Beam, Module 90, Q90 LED and AP 1200 LED

9XD 990 298-031

**Plastic bracket**

Glass fibre-reinforced standard bracket for worklights.

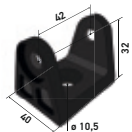

**Model series:** Ultra Beam, Mega Beam, Oval 100, Double Beam, AS 200, Power Beam, Module 90, Q90 LED and AP 1200 LED

42 mm bracket width

8HG 332 912-002

**Standard bracket**

With extra space to the rear.

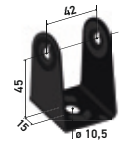

**Model series:** Ultra Beam, Mega Beam, Oval 100, Double Beam, AS 200, Power Beam, Module 90, Q90 LED and AP 1200 LED

42 mm bracket width

8HG 992 377-042

**Oblong hole bracket**

Special bracket with oblong hole for mounting.

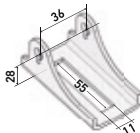

**Model series:** Oval 90, Module 70, PowerXen and Flat Beam 500

36 mm bracket width

8HG 331 414-372

**Forked bracket**

Special bracket for flat mounting

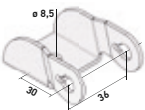

**Model series:** Oval 90, Module 70, PowerXen and Flat Beam 500

36 mm bracket width

8HG 994 412-372

**Standard bracket with eye**

Standard bracket for attachments with little space to the rear.

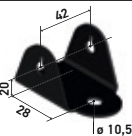

**Model series:** Ultra Beam, Mega Beam, Oval 100, Double Beam, AS 200, Power Beam, Module 90, Q90 LED and AP 1200 LED

42 mm bracket width

8HG 994 974-002





### Connector

The extensive range of accessories for plug connections from HELLA offers solutions for almost any usage scenario. Undesired failures are often caused not by the products but by defective cabling or wiring. The HELLA SUPERSEAL product range helps to achieve a water-tight and dust-resistant connection of the cable heads, thereby offering ideal work conditions whatever the weather.

GERMAN plug set, 2-pin	8JA 201 022-801
GERMAN plug set, 6-pin	8JA 201 022-831
AMP connector set (consists of AMP connector and flush-mount grommet)	8JD 990 295-037
HB3 connector (10x)	8JA 990 295-217
H9 connector (20x)	8JD 158 175-807
SUPERSEAL, case containing an assortment of various SUPERSEAL connectors, male/female contacts, individual cable seals and sealing plugs (780 parts).	8JA 009 256-801

### Cables

HELLA supplies various adapter cables as accessories for easy installation of headlights.



2,000 mm cable with AMP connector and bare cable heads	8KB 990 299-001
2,000 mm cable with DEUTSCH connector and bare cable heads	8KB 990 299-011
2,000 mm cable with H9 connector, bare cable heads and rubber cap	8KB 990 299-311
2,000 mm cable with HB3 connector and bare cable heads	8KB 990 299-331
200 mm adapter cable from DEUTSCH to AMP connector	8KB 990 299-361
230-volt power supply (suitable for work lights up to max. 45 W)	8EN 332 584-001

### Bulbs

HELLA's bulb assortment offers a range of bulb types specially developed for different purposes, e.g. Light Power with extremely powerful light output or Lifetime with a very long design life.

Even more can be found at [www.hella.com/bulbs](http://www.hella.com/bulbs)



H3 12 V / 55 W	8GH 002 090-133
H3 24 V / 70 W	8GH 002 090-251
HB3 LL 12 V / 60 W	8GH 005 635-181
H9 12 V / 65 W	8GH 008 357-001
D1S xenon bulb	8GS 009 028-001

## A diverse range of accessories

Away from the roads, the demands made on man and machinery are highly exacting. HELLA offer branded top quality accessories and a huge selection of diverse spare parts and add-ons – for any situation.



### Rocker switches

Many rocker switches are specially designed for use in cars, commercial vehicles, agriculture and construction machinery and special vehicles. There are more than 500 different switch symbols available for all switch series.

The new waterproof 3100 series for electrical systems is the latest addition to the HELLA rocker switch series. It meets the requirements of protection class IP 68. The lasered symbols are lit by integrated LEDs.



### Horns and backup alarms

Horns and trumpet horns also have a long tradition at HELLA. The company has been developing and producing acoustic signal units for almost 100 years. The product range includes signal horns, super-tone horns, electronic dual-tone trumpet horns and supercharger and air trumpet horns.



For more information:  
[www.hella.com/switch](http://www.hella.com/switch)



For more information:  
[www.hella.com/horns](http://www.hella.com/horns)



### Ignition and starter switches

Nothing works without it. The ignition switch is chiefly responsible for reliably starting the engine. Reliability and durability are its key properties.



### Battery isolator switch

Offer effective security from theft and fire in the event of accidents in the agricultural machinery industry. They are resistant to dust and waterproof according to IP 69. Switching is also partially possible under a load of 250 A.



### Wiper blades

In the course of their lives, the small technical wonders wipe several thousand litres of water off the windshield and have to contend with snow, ice, insects and much more. A good reason to choose quality wiper blades from HELLA.



Further information:  
[www.hella.com/wiperblades](http://www.hella.com/wiperblades)

## HELLA work lights in blister packaging

In addition to original equipment, HELLA is also a major player in the aftermarket and spare parts sectors.

Upgrade your showroom with high-quality work lights from HELLA. Stylish blister packaging allows you to give your customers a great first impression of the products, the design and the technical details.

**The following products are also available in blister packaging:**

- Ultra Beam LED Gen. I
- Module 70 LED Gen. III
- Mega Beam LED Gen. III
- Power Beam 1500
- Oval 90 LED Gen. I
- Oval 100 LED Gen. I



**Ultra Beam LED Gen. I**  
1GA 995 506-002

Page 51



**Module 70 LED Gen. III**  
1G0 996 276 -453

Page 53



**Mega Beam LED Gen. III**  
1GM 996 136-312

Page 55





**Power Beam 1500**  
1GA 996 288-012

Page 58



**Oval 90 LED Gen. I**  
1GB 996 386-002

Page 61



**Oval 100 LED Gen. I**  
1GA 996 661-002

Page 63



## Born to Work in the Toughest Conditions

Thanks to state-of-the-art technologies developed using our OE know-how, HELLA work lights are able to withstand the most difficult of environmental conditions. And it is the sophisticated thermal management within the work light in particular that makes for a very long service life. After all, only when the heat can be optimally dissipated from the high-power LED work lights can high-power illumination performance take place unhindered. Go for the best quality and rev up your working efficiency. This is where you can find out more about the latest work light innovations from HELLA.

### CoroSafe New process to combat corrosion



CoroSafe coating: for when the going gets really tough.

HELLA is setting standards in work light durability and toughness with its new CoroSafe coating. Two additional layers of surface coating on the work lights greatly improve their durability. The sophisticated combination of different coating methods ensures a high level of corrosion resistance and improved protection against damage to the work lights. This means that the housing is well protected and ideal for use in harsh environments with large amounts of salt and water. CoroSafe is used primarily in HELLA LED work lights and LED reversing lights.

All HELLA work lights that have a CoroSafe coating are instantly recognisable thanks to their grey housing. This makes it easy to distinguish them from other HELLA work lights.

### THERMO PRO series A HELLA innovation



Special thermally conductive plastics ensure optimum heat dissipation from the LEDs.

The innovative plastic material of the THERMO PRO series boasts similar thermal conductivity properties to aluminium. This means that the LEDs can operate using the full power supply, even in high ambient temperatures.

In addition to this, the THERMO PRO series impresses with its considerably reduced weight and improved vibration characteristics. Even in the toughest conditions, the omission of vulnerable aluminium and the use of plastic housings ensure a long service life and prevent corrosion.

#### Advantages:

- Especially suitable when corrosion risk is high, e.g. corrosion of work lights caused by salts
- Optimal vibration behavior thanks to reduced weight
- Plastic material is resistant to external factors such as dust, dirt and water (IP 6K9K / IP 6K8 protection classes)



Video clip – CoroSafe and Thermo Pro  
Scan the barcode and watch the video to learn more.

## Optimum Working Conditions in Total Darkness

The right light is always important – especially when working at night. The more light and lumens the better – at least that's what many people believe. But at HELLA, we know better. Too much light is usually the wrong approach. The high colour temperature of the LED work lights (~ 6,500°Kelvin) means that too much light often causes a glare effect. The engineers at HELLA have tackled this problem and have come up with two solutions.

### ZEROGLARE



In order to guarantee the same safety and comfort in mines as experienced on the road, HELLA has developed a new optical system for work lights.

The **ZEROGLARE** system ensures that drivers of oncoming vehicles are not dazzled. Unlike conventional LED work lights, the cut-off line is very sharp, and the light of the ZEROGLARE work lights is directed specifically onto the area in front of the vehicle.

HELLA's RokLUME 380 work light is now available with this new **ZEROGLARE** technology. The 5,000 Kelvin colour temperature is very similar to that of natural daylight, thus ensuring safer working conditions. The housing is made of corrosion-resistant aluminium protected by a special NanoSafe coating, which safeguards the work light against external influences. It also has the advantage of easy cleaning. Product details can be found on page 49.

Find out more about the new **ZEROGLARE** technology by visiting [www.hellazeroglare.com](http://www.hellazeroglare.com)



Video clip – **ZEROGLARE**  
Scan the barcode and watch the video to learn more

### Coloured cover lenses



Coloured cover lenses are used in cases where white LED light might dazzle drivers.

#### Coloured cover lenses:

- Generate a comfortable colour temperature and reduce the prevalence of fatigue.
- Create safe working conditions under a variety of environmental influences.
- Improve contrast perception.

#### 1. Blue lens:

##### **70 LED module (Part No.: 1G0 996 276-701)**

- Particularly well suited to use on sprayers.
- The focused light beams penetrate the spray mist and all nozzles are evenly illuminated.

#### 2. Orange lens:

##### **Power Beam 1500 (Part No.: 1GA 996 288-041)**

- Particularly well suited to snow ploughs.
- The orange light optimises visibility conditions, particularly in the presence of fog and on surfaces with different textures.



Video clip – Coloured cover lenses  
Scan the barcode and watch the video to learn more





## Simple answers to technical questions...

### What do watt, Kelvin, lumen and lux mean?

**Watt (W):** unit of measure for the power requirement of a headlight

**Kelvin (°K):** unit of colour temperature; the higher the value, the "whiter"/more similar to daylight the light is.

IMPORTANT: anything above 7,000° Kelvin is too glaring for the human eye and causes dazzle

**Lumen (lm):** The amount of light emitted by the light source, but in all directions.

IMPORTANT: difference between measured and theoretical lumen. HELLA states only actual measured light values.

**Lux (lx):** this value is important for the illumination of the work area. The aim is to illuminate the ground as strongly as possible. Computer-generated reflector surfaces which focus the light and thus produce homogenous illumination are used here.

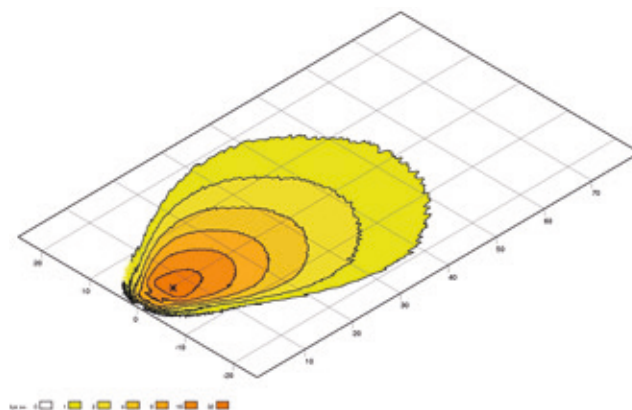

Isolux diagrams are used to compare illumination. The intensity of illumination is measured with an incident light meter to determine if a work area is sufficiently lit up.

### How can you compare the illumination of different lights?

In the course of the LED revolution, the term "lumen" for the unit of strength of a worklight was strained to the extent that a kind of "battle of the lumens" took place. In order to come out on top, a number of manufacturers started quoting only calculated light values. These values are often far off reality and result in disappointment when switching on the headlight. The best situation is a direct comparison of the headlights at night – this makes the purchasing decision much easier.

### Why are different inclination angles specified?

The reflector is designed to provide optimum light output that is as uniform as possible at the specified inclination angle.

### Why is the tilt angle of the worklight so decisive?

The tilt angle is measured at the mounting point of the worklight, below the horizontal. The larger the tilt angle, the more intense the light is in the core area. A small tilt angle generates a large light beam in the distance. Several worklights (even different worklights) can be combined to achieve custom illumination of the surroundings.



**Are there any legal regulations which apply to worklights?**

There are no specific regulations for type approval, as worklights can only be used while driving off public roads.

**Who is allowed to install worklights on their vehicles?**

Worklights can be installed on any vehicle.

**Can I use worklights in road traffic as well?**

Yes, if the vehicle is stationary (e.g. loading and unloading). Exception: vehicles used for building, maintaining, street cleaning or refuse collection, if the trip is part of the working process. Worklights may then only be switched on if they do not dazzle other road-users.

**Can other headlights be used as worklights?**

For vehicle lighting, special headlight types were developed depending on their area of application: low beam, spotlights, fog lights and worklights. Only worklights can provide sufficient illumination to illuminate the field of work. A good worklight is characterised by even illumination, as large a surface as possible and a gentle transition in the edge area. (see fig. 1)

**Can I switch on worklights in public traffic when it is foggy?**

No. Worklights must not be used while driving on public roads.

**When can I use a worklight as a reversing spotlight?**

When an approved reversing spotlight is involved – only with the ECE-R23 approval mark. HELLA also offers a reversing spotlight variant from several ranges: Ultra Beam, Power Beam 1000 (LED), Module 70 LED.

**Does the light yield of headlights double with two bulbs?**

The more light sources are used, the more luminous efficiency in the work area. The light output, however, depends on the light source and the reflector lens system. Two bulbs therefore signify a plus in light performance.

**What is the difference between the two different types of illumination?**

- 1) Close-range illumination: intensive light for the area near the vehicle, range approx. 20 m to 40 m, wide diffusion.
- 2) Long-range illumination: rather narrow diffusion (approx. 12-15° to the left and right), range between > 40 m - 150 m (depending on installation height and tilt angle).

**Can I combine worklights which use different technologies?**

Yes, there is nothing to stop you attaching xenon or LED worklights to a vehicle with Halogen lighting. Many end users retrofit their vehicle step by step, so as to split the capital outlay over several stages.



Low beam  
Fig. 1



High beam



Fog light



Working light

**Why is the installation height of a worklight important?**

The light appearance changes depending on the different installation heights. A uniform installation of 2.5 m was taken for the light diagrams in the catalogue. (Figs. 2 and 3)

**When are upright and suspended versions of a worklight available?**

If the light distribution is not symmetrical, there are different varieties for suspended installation. Please refer to the HELLA product text or to the installation instructions to check whether a headlight is suitable for suspended installation.

**How long is the service life of a HELLA LED worklight?**

The service life of the entire worklight system is dependent on environmental influences such as vibration, exposure to salt, temperature, etc. The service life of the LED itself is usually very long, but decreases under the influence of temperature.

The light unit of HELLA's high-power LED worklights is designed in such a way that 70% of the original light power is still available after 60,000 hours. (In the case of "Mid-Power LED Worklights", for example the Flat Beam LED, this value is reached after 10,000 hours).

**Do I need an additional relay to install a LED worklight?**

Protection is required particularly for LED devices with higher power. More detailed information is listed in the installation instructions for the respective HELLA LED worklight.

**Can I activate worklights at the same time as other headlights (e.g. high beam and worklights)?**

No. It must be possible to switch on worklights independently of all other headlights and lights.

**Do I need an additional relay to install a xenon worklight?**

Yes, because the current required to ignite the burner briefly reaches 20 A (at 12 V) or 10 A (at 24 V), so a fuse is required (15 A for 12 V systems, 7.5 A for 24 V systems).

**What cable diameter is required for a xenon worklight?**

Please observe that cables with sufficient cross-section are used. The recommendation is to use a 2.5 mm<sup>2</sup> cable with a max. length of 5 m.

**What types of connectors are there?**

HELLA offers different connector systems for electrical contact. Either the connector is integrated into the casing or mounted on to a cable (AMP/German), or it depends on the bulb (e.g. H9/HB3). The DEUTSCH connectors and mating connectors used most in the automotive industry for H9/HB3 bulbs are not widely available on the aftermarket. HELLA offers adapter cables for this purpose to enable simple electrical contact.

**Why are there LED worklights with coloured lenses?**

There are areas of application in which white LED light can dazzle the driver. That's why HELLA has developed special versions with coloured worklights. The coloured cover lens produces a more pleasant colour temperature and thereby reduces dazzle.

Blue: snow ploughs, sprayers, fog, ...

Orange: mining and construction



Low installation position  
Fig. 2



High installation position  
Fig. 3

### Can I clean the HELLA worklight with a high-pressure cleaner?

This information can be inferred from the IP protection class in the product information. All headlights with a protection class of IP 5K9K or IP 6K9K cannot be damaged by water from a high-pressure/steam jet cleaner directed against the housing at a water pressure of approx. 80 to 100 bar.

### What does 'heavy-duty' mean?

Heavy-duty indicates that the product can withstand extreme stress. Heavy-duty worklights go beyond the already very high standard and are equipped with additionally reinforced brackets or vibration dampers that withstand even tougher conditions.

### How are HELLA LED worklights shake-proof?

LEDs are semiconductor components, which means they do not have a fragile filament. That is why they are absolutely shock and vibration resistant, which guarantees optimal lighting even under extreme conditions.

### What does electromagnetic compatibility (EMC) mean?

LED and xenon headlights can emit radiated interference and thus adversely affect the on-board electronic system. HELLA is deeply committed to developing premium, interference-free headlights. That's why, alongside the statutory ECE-R 10 and C-TICK test, other tests are performed according to the CISPR25 standard. The requirements tested there are far higher and ensure that radio and GPS signal reception are not affected. HELLA meets the highest automotive standards in the main frequency ranges. (CISPR25 class 5)

### Hazardous goods ordinance

GGVSEB (previously GGVS) means the hazardous goods ordinance for roads, railways and inland waterways. This ordinance implements the European Parliament and Council Directive 2008 / 68 / EC of September 24, 2008 on the inland transport of hazardous goods. Worklights with this mark are approved for installation on conveyances that must comply with the provisions of GGVSEB / ADR.

### HELLA work lights with ADR/GGVSEB approval

Power Beam 1500 (1GA 996 288-xx)  
 Power Beam 1800 (1GA 996 388-xx)  
 Power Beam 3000 (1GA 996 192-061)  
 Ultra Beam LED (1GA 995 506-xx)  
 Modul 50 LED (1G0 995 050-xx)  
 Modul 90 LED (1G0 996 263-031/-051)  
 Oval 100 LED (1GA 996 661-xx)  
 Oval 90 LED (1GB 996 386-xx)  
 Q90c LED (1GA 996 284-031/-081/-091)





**Which IP protection classes are there?**

**And what do they mean?**

IP stands for International Protection. The standard exists to specify the precise protection of electrical devices from ingress of solid or liquid foreign objects, e.g. dust or water, on a standardised basis. The exact degree of protection is calculated using a series of standardised tests.

Degrees of protection against solid foreign objects (dust)			Degrees of protection against water		
First digit	Brief Description	Definition	Second digit	Brief Description	Definition
0	Not protected	No requirements	0	Not protected	No requirements
1	Protected against solid foreign objects > 50 mm	The object probe, a sphere 50 mm in diameter, must not be able to penetrate completely	1	Protected against drops of water	Vertically falling drops shall have no harmful effect
2	Protected against solid foreign objects with diameter > 12.5 mm	The object probe, 12.5 mm in diameter, must not penetrate at all	2	Protected against drops of water when the housing is tilted by up to 15°	Vertically falling drops must have no harmful effect if the enclosure is tilted to an angle of up to 15° to both sides from its normal position
3	Protected against solid foreign objects with diameter > 2.5 mm	The object probe, 2.5 mm in diameter, must not penetrate at all	3	Protected against spray water	Water that falls as a spray at an angle of up to 60° on both sides of the perpendicular shall have no harmful effect
4	Protected against solid foreign objects with diameter > 1.0 mm	The object probe, 1.0 mm in diameter, must not penetrate at all	4	Protected against spray water	Water that is sprayed from one direction against the housing shall have no harmful effect
			4K	Protected against splashwater at increased pressure	Water that is sprayed from every direction at increased pressure against the housing must not have any damaging effect
5K	Dust protected	The penetration of dust is not prevented completely, but dust must not penetrate to such an extent that the satisfactory operation of the device or its safety are affected	5	Protected against sprayed water	Water projected in jets against the housing from any direction shall have no harmful effect
6K	Dustproof	No ingress of dust	6	Protected against powerful water jets	Water that is sprayed from every direction against the housing at considerable pressure must not have any damaging effect
			6K	Protected against powerful sprayed water with increased pressure	Water projected in powerful jets at increased pressure against the housing from any direction shall have no harmful effect
			7	Protected against the effects of temporary immersion in water	Ingress of water in harmful quantity shall not be possible when the housing is temporarily immersed in water under defined conditions of pressure and time
			8	Continuous immersion in water	Ingress of water in harmful quantity shall not be possible when the housing is continuously immersed under water under defined conditions
			9	Protected against the effects of continuous immersion in water	Water must not seep in to the extent that it causes damage if the housing is permanently immersed under water under pressure and time conditions
			9K	Protected against water during high pressure/steam jet cleaning	Water projected in jets at increased pressure against the housing from any direction shall have no harmful effect

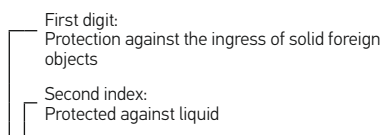

Code letters

**IP 6K5**



## Quality comes first at HELLA

**HELLA has set itself the ambitious standard of guaranteeing consistently high product quality in every respect.**

This is achieved by defining quality criteria and checking every detail using carefully-selected methods throughout the entire manufacturing process. Production quality is ensured by parallel quality monitoring and testing. Quality products from HELLA are subject to different test procedures in accordance with HELLA Norm 67101. These test procedures are conducted by the certified HELLA test laboratory in Lippstadt.

### **First-class quality by conviction**

HELLA guarantees the perfect, long-term functioning of its products and stands for satisfied customers in the spare parts, accessories and light sources areas.

### **HELLA products are subject to the following tests:**



#### **Splash water test**

In universal splash water cabins, HELLA products are tested under realistic environmental conditions. The booths are equipped with devices for rain, splash water, water jets and water mist. Here, the test products are tested for tightness by undergoing the intermittent and splash water test at a pressure of up to 5 bar, and the sprayed water test at a pressure of up to 10 bar. (IP XK4K)



#### **Pressure washer test**

In one test system, the products are exposed to a water pressure of up to 120 bar and a water temperature of 85°C. This test simulates cleaning in a carwash or with a pressure cleaner (IP 6K9K).



#### **Dust test**

The purpose of the dust-protection test is to test to what extent a worklight is protected from the penetration of foreign solid bodies, including dust. For this, the device is exposed to an air/dust mixture for a period of 5 hours. This is the only way that HELLA can ensure that dust will not penetrate the product and can guarantee the long design life of the product.

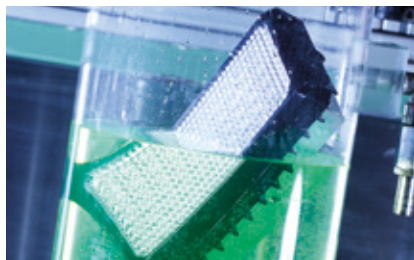

#### Immersion and pressure tightness test

Depending on requirements, this test is carried out for all lighting technology products. An immersion pipe can be submerged to a depth of 1 m in water. Another test system can reach a depth of 6 m. Also, an overpressure test up to 1.6 bar is conducted in an immersion pool. All tests are carried out in accordance with HELLA Norm 67101 and statutory requirements (IP 67).



#### Heat, moisture and cold test

In temperature cycle tests, HELLA products are exposed to temperature fluctuations from  $-40^{\circ}\text{C}$  to  $+100^{\circ}\text{C}$  in climatic chambers which have a volume of 600 to 1,000 litres. In addition, condensation and defogging tests are carried out up to max. 95% air humidity and up to  $80^{\circ}\text{C}$ . In the "shock chamber", the temperatures change within seconds (intervals of max. 6 seconds) between  $-40^{\circ}\text{C}$  and  $+100^{\circ}\text{C}$ . These tests signify the utmost stress for any material, both for lighting as well as for the individual electronics components. The heat and cold tests last up to 48 hours.



#### Salt spray test

The tough environmental conditions of life on the road are simulated in the salt spray test. A salt spray swirls around the worklights for up to 720 hours to test their corrosion resistance. Where others rapidly give up, HELLA impresses with quality and excellent robustness. High salt spray resistance is particularly important for reversing spotlights. The low attachment height on the rear of the vehicle means that the lights are exposed to the toughest conditions (e.g. water, salt, stone chippings, ...).



#### Vibration test

HELLA worklights survive the harshest conditions every day. This test simulates the behavior of the products over a "poor stretch of road" and shows, for example, reactions to potholes, gravel tracks, gravel, stones, fields and dirt roads. The wideband random vibration test is used to test the mechanical endurance strength in the vertical and horizontal axes. Here, the frequency range extends from 10 to 1000 Hertz. Alongside the vibration test, the products are subjected to a temperature overload of  $-40^{\circ}\text{C}$  to  $+80^{\circ}\text{C}$ . Among others, this checks the ageing process of the plastic. All products are tested for function for up to 24 hours. Furthermore, a mechanical shock test is conducted during this procedure. This simulates the behavior in the event of jolts (products in packaging during shipping) with an acceleration of between 300 and 500 m per second<sup>2</sup>.



More information on HELLA quality criteria  
can be found at: [www.hella.com/agriculture](http://www.hella.com/agriculture)



## HELLA quality: a comparison

Where others are cutting back, HELLA is investing in top quality. Find out in detail why supposedly cheap products from discount suppliers can turn out to be very expensive.

### Surface coating



High quality coatings protect the aluminum components of HELLA worklights from salt and chemicals and therefore from corrosion.



Corrosion can ruin the seal on lights. In the worst case, water can penetrate and destroy the electronics.

### Thermal management



The thermal management of HELLA worklights is thoroughly calculated. The heat of the LEDs is evenly distributed and deflected via the housing. If there is a risk of overheating, individual LEDs are automatically dimmed.



Without thermal management, LEDs can very quickly overheat. This makes their service life drop dramatically. Hot spots can deform the entire electronics board, soldering connections can break, causing the complete light to fail.

### Electromagnetic compatibility (EMC)



The LED arrangement in HELLA's worklights and the construction of the reflector ensure that no interference occurs from magnetic fields.



LED lights that are not correctly shielded, produce strong electro-magnetic fields which interfere with the electronic system, radio and GPS.

### Electro-static discharge (ESD)



Before HELLA employees are allowed to enter the LED production, they have to be statically discharged to ensure that no components can be damaged by charging.



Static discharge caused by damaged electronic components can make entire lights unusable. There is a threat of expensive downtime.

### Reverse polarity



HELLA worklights are protected against reverse polarity. If they are wrongly connected, they will not be damaged.



If a wrongly connected light is not protected against reverse polarity, the electronics will be completely destroyed when it is switched on.

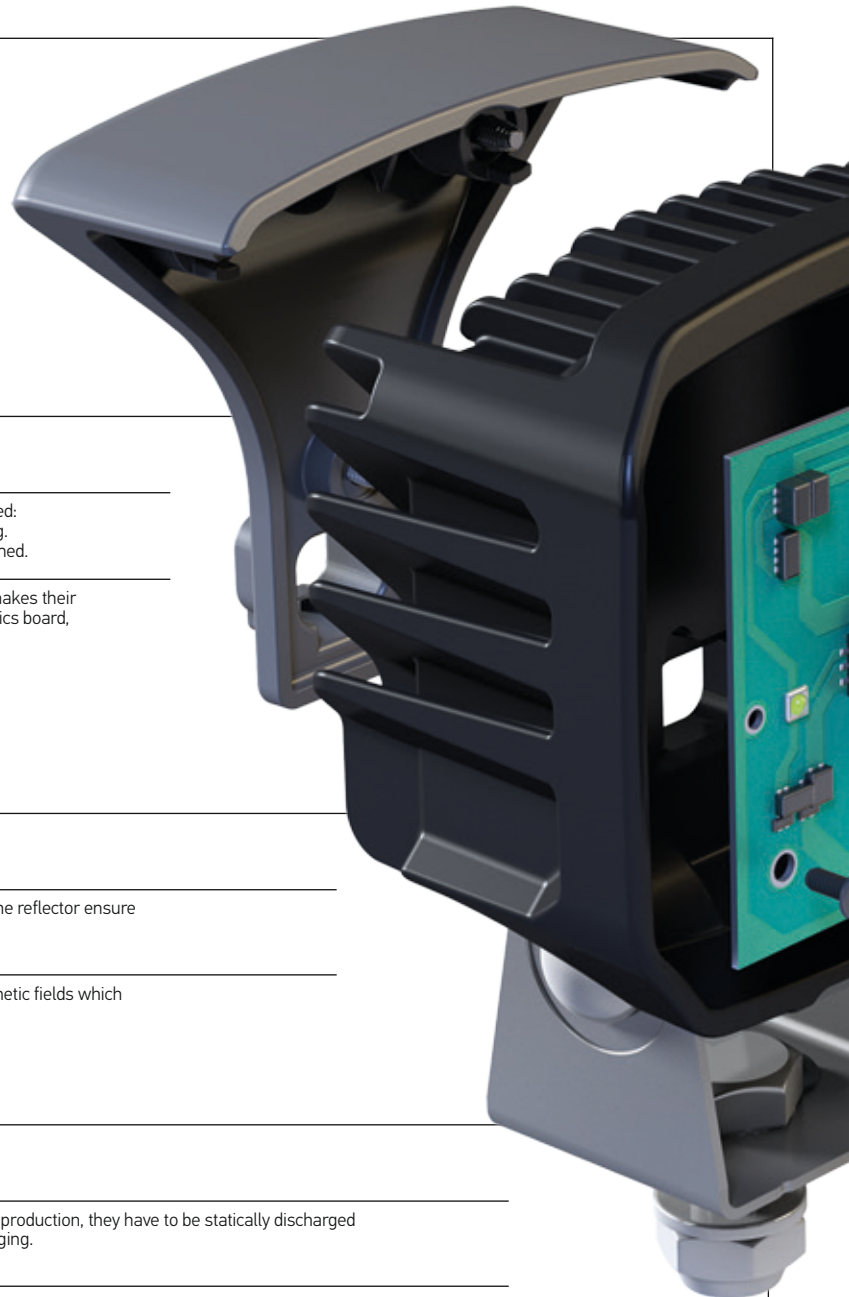

### HELLA quality advantages



### Where others save

Attempting to save in the wrong place, costs more in the end, as inferior lights provide less power and often fail.

## Quality of the LEDs



Only LEDs that have undergone strict tests are used in HELLA worklights. The selection guarantees the extremely long design life of the LEDs of up to 60,000 hours.



Resorting to untested, cheap LEDs brings the risk of a shortened service life and malfunction. Then LED technology cannot be used to its full advantage.

## Adhesion



The worklights at HELLA are hermetically sealed by high-accuracy glue-dispensing robots. This guarantees that the lens is glued at an optimal angle for the optimum light yield which has been precisely calculated.



Inferior lights are often glued manually. An irregular adhesive bed can lead to the lens angle, and thus the light yield, not being ideal. If the lens is no longer tight or becomes detached, water can penetrate and make the light unusable.



## Light distribution via the reflector system



The reflectors of HELLA worklights are calculated in such a way to ensure that the working area is evenly illuminated and the light optimally used.



Worklights with an unsuitable light control system illuminate the working area unevenly and waste a large part of the light. Brighter spots distract your eyes, making other details difficult to see.

## Lens material



The lens in HELLA worklights, which is 100% suitable for daily use, consists of a high quality, impact and scratch-proof plastic. The light emitted remains homogeneous, even after colliding with a branch or anything similar.



Lenses made of inferior plastic can break and scratch easily. Each scratch leads to undesired light refraction – the more there is, the more irregular the illumination.

## Find the right product with ease

More information on HELLA worklights, with videos, animations and product details, can be found on the internet. Interactively experience worklights with our app for smartphones and tablets.



### Agriculture website

Informative, compact, interactive. Here you will find all you need to know about the products and technologies for agricultural application.

[www.hella.com/agriculture](http://www.hella.com/agriculture)



### ELIVER - the light comparison tool

This online tool enables you to compare many HELLA worklights and beacons on the basis of their illumination in a realistic environment.

 [www.hella.com/eliver](http://www.hella.com/eliver)



www.hella.com/worklight-configurator

### Worklight configuration tool

Which worklight is the correct one for your application? The HELLA online configurator will provide you with suitable product suggestions including all the relevant information about the product.



### Mobile App Worklights

Let yourself be drawn into the interactive world of worklights and experience the variety of lighting technologies, explosion animations and much more. Simply download the app from iTunes or Google Play!

[www.hella.com/worklight-configurator](http://www.hella.com/worklight-configurator)

**HELLA KGaA Hueck & Co.**

Rixbecker Straße 75  
59552 Lippstadt, Germany  
Tel.: +49 2941 38-0  
Fax: +49 2941 38-7133  
Internet: [www.hella.com](http://www.hella.com)

**HELLA Asia Singapore Pte Ltd**

Regional Headquarters Asia Pacific  
Independent Aftermarket  
2 International Business Park  
#02-12 The Strategy  
Singapore 609930  
Tel: +65 6854 7300  
Fax: +65 6854 7302  
E-mail: [singapore@hella.com](mailto:singapore@hella.com)  
Internet: [www.hellaasia.com](http://www.hellaasia.com)

© HELLA KGaA Hueck & Co., Lippstadt  
J01243/08.16

Subject to technical and price modifications.